



徐工徐工 助您成功
XCMG FOR YOUR SUCCESS

XLC30000

CRAWLER CRANE
履带起重机



地址(Add): 中国江苏省徐州市金山桥经济开发区桃山路19号 邮编(Postal Code): 221004
No.19 Taoshan Road, Economic development zone of jinshanqiao, Xuzhou, Jiangsu Province, China
统一服务热线(Unified service hotline): 86 400-110-9999

销售热线Sales Hotline
销售电话(Sale Tel): 86 0516-87892094
销售传真(Sale Fax): 86 0516-87892074
电子邮件(E-mail): jjyxd@xcmg.com
服务质量投诉电话
(Quality Supervision Tel): 86 0516-87892587

服务热线Service Hotline
服务电话(Service Tel): 86 400-001-5678
服务传真(Service Fax): 86 0516-87892080
备件电话(Service Tel): 86 0516-87892086
备件传真(Service Fax): 86 0516-87892083



欢迎访问徐工商城
省心更省钱一站式



欢迎关注徐工履带起重机官方微信
1. 直接扫码“XCMG_xgj”增加好友。
2. 查找公众账号“徐工履带起重机”
3. 直接扫描上方二维码

—2022年1月版—

注: 出于产品不断改进的需要, 我们保留对产品型号、参数、配置进行变更的权力, 恕不另行通知。



CONTENTS

- P02** |
- Description of Components and Systems
 - Safety Precautions
 - Main Technical Parameters

- P11** |
- Heavy-duty boom SHB
 - Lightweight boom SLB
 - Luffing jib SHW
 - Special jib SHV
 - Fixed jib SHF
 - Special boom SXT
 - Strengthened heavy-duty boom SHB-DS
 - Strengthened lightweight boom SLB-DS
 - Strengthened special jib SHV-DS
 - Strengthened fixed jib SLF-DS

- P46** |
- Transport Plan

02

XLC30000 CRAWLER CRANE

P03-P04 Description of Components and Systems

P05-P06 Safety Precautions

P07-P10 Main Technical Parameters

Description of Components and Systems

1. Boom telescoping code

Chord and cornice of XLC30000 crawler crane boom are made of high-strength seamless steel pipes, whose middle uniform section is welded with segmented high-strength steel plate and whose variable cross-section at both ends forms a truss structure that consists of four chords.

①SHB: Heavy-duty boom, length: 54 m~120 m. Composition: base section of boom × 1, middle section A of 12 m boom × 1, middle section A of 6 m boom × 1, middle section B of 6 m boom × 1, middle section B of 12 m boom × 1, middle section E of 12 m boom × 2, middle section C of 12 m boom × 2, center hitch section of 12 m boom × 1, middle section D of 12 m boom × 1, boom head × 1, winch tackle A × 1, and winch tackle B × 1.

②SLB: lightweight boom, length: 114 m~168 m. Composition: base section of boom × 1, middle section A of 12 m boom × 1, middle section A of 6 m boom × 1, middle section B of 6 m boom × 1, middle section B of 12 m boom × 1, middle section E of 12 m boom × 2, middle section C of 12 m boom × 2, center hitch section of 12 m boom × 1, middle section A of 12 m luffing jib × 1, luffing jib transition section × 1, middle section of 6 m luffing jib × 1, middle section B of 12 m luffing jib × 1, middle section C of 12 m luffing jib × 1, middle section D of 12 m luffing jib × 1, luffing jib head × 1, and winch tackle A × 1.

③SHW: luffing jib; luffing jib of 36~108 m can be installed on the boom of 54~108 m. Composition: base section of luffing jib × 1, middle section A of 12 m boom × 1, luffing jib transition section × 1, middle section of 6 m luffing jib × 1, middle section B of 12 m luffing jib × 1, middle section C of 12 m luffing jib × 1, middle section D of 12 m luffing jib × 1, middle section E of 12 m luffing jib × 1, center hitch section of 12 m luffing jib × 1, luffing jib head × 1, and winch tackle A × 1.

④SHV: special jib; special jib of 18 m can be installed on the boom of 54~120 m. Composition: base section of luffing jib × 1, luffing jib transition section × 1, luffing jib boom × 1.

⑤SHV: fixed jib; fixed jib of 12~18 m can be installed on the boom of 114~144 m. Composition: base section of fixed jib × 1, middle section of fixed jib × 1, top section of fixed jib × 1.

2. Turntable

With a front-rear separated structure used, the turntable reduces the transport weight. The overall structure pattern is a large-box frame with constant strength, and I-shaped main vertical plates at both sides are connected with box girders and are welded using high strength steel plates. This structure is bending resistant and torsion resistant with good stability. In the turntable, a winch system and a luffing system are installed. The power box system is installed on the left of the turntable by connecting the beam. The turntable is connected with the frame through the slewing assembly.

3. Pendant

It is a high strength pendant structure composed of two groups of pendants. Pendants are made of high strength steel plates that are smoothly cut, which increases safety. Pendants are equipped with a walking beam that can balance loads that two groups of pendants are bearing, so pendants are under even loads.

4. Mast

Chord and cornice of masts are made of seamless steel pipes, whose middle uniform section is welded with segmented high-strength steel plate and whose variable cross-section at both ends form a truss structure that consists of four chords. The mast is 50 meters long, including one base section, two 12 m sections, one 6 m section, and one top section. The mast is configured with the hydraulic-automatic-control anti-back-tipping mechanism.

5. Mechanism composition

See the table below for crane mechanisms and corresponding applications:

No.	Name	Use	Location
1	Main winch system	Elevation operation boom, jib and luffing jib	Turntable
2	Auxiliary winch system	Elevation operation for boom, jib and luffing jib	Turntable
3	Single sheave winch system	Single sheave elevation operation	Turntable
4	Mast luffing system	Mast luffing operation	Turntable
5	Boom luffing system	Boom luffing operation	Mast base section
6	Luffing system of luffing jib	Luffing operation of luffing jib	Base section of main boom
7	Slewing system	Superstructure slewing	Turntable
8	Traveling mechanism	Machine travel	Crawler beam
9	Reeving system	Assist in reeving wire rope	Turntable

6. Winch system

The main winch system and the auxiliary winch system share the same model. They are independently driven and can work simultaneously. Winch system has a disc type normally closed brake, a built-in speed reducer and is driven by a variable motor. Main and auxiliary winch systems use box shaped supports connected to turntable via hydraulic kinetic pin. Winch system uses counter-rotation wire rope. The wire rope diameter is $\Phi 40$ mm.

7. Luffing system

The mast luffing system uses the double drum structure. It uses the ratchet locking system, the chip normally engaged brake, the built-in speed reducer, and the variable displacement motor. It uses the box brackets and are connected with the turntable through the hydraulic power pins. The wire rope diameter is $\Phi 32$ mm.

The boom luffing system uses the ratchet locking system and the chip normally engaged brake, has the built-in speed reducer, and is driven by the variable displacement motor. It uses a box bracket and is arranged on the base section of the mast. The wire rope diameter is $\Phi 40$ mm.

The luffing jib luffing system uses the ratchet locking system and the chip normally engaged brake, has the built-in speed reducer, and is driven by the variable displacement motor. It uses a box bracket and is arranged on the base section of the boom. The wire rope diameter is $\Phi 40$ mm.

8. Slewing assembly

The slewing assembly includes the slewing bearing, slewing reducer, and upper and lower flange plates.

Six-row roller type external tooth slewing ring is used, and characterized by high strength and large bearing capacity, providing convenience for maintenance and repair. Six planet-gear reducers are arranged in front and rear to externally mesh with slewing bearing, realizing hydraulic cushion and free slipping. It adopts a disc type normally closed brake that works reliably and is maintenance friendly.

The upper and lower flange plates are connected with the turntable and frame using the hydraulic power pins arranged clockwise. The power pin connection extension and retraction can be realized by one clicking, which is convenient and fast.

9. Power box

The power box is located on the left of the turntable. In the front, the operator's cab is equipped; in the rear, the engine system, hydraulic system, and the control system are equipped. Operator's cab is a steel framework; glass for forefront windshield is integral laminated glass and for other places is toughened glass. The cab is equipped with adjustable seat and a complete set of instruments and control devices that are in line with Ergonomics; besides, it also contains air conditioner (air channel type; cool and heat), sound equipment, fire extinguisher and closed-circuit monitoring system, and it has a large inner space that offers comfort.

10. Chassis

The chassis is composed of a frame, articulated beam, crawler frame, etc. With the box structure used, they are all made of high-strength steel plates, with transverse partition added in the middle to strengthen torsional rigidity. The chassis has a simple structure, strong carrying capacity and good rigidity. Parts are connected using hydraulic power pins. Hydraulic power pins arranged in a ring structure are used between the frame and slewing assembly.

11. Crawler unit

It includes crawler beam, track roller, driving wheel, guide wheel, carrier roller and track shoe. Crawler beam, with a two-split box structure used, is equipped with a transverse partition added in the middle and partially strengthened in the part connected with the frame. Track roller, driving wheel, guide wheel, carrier roller and track shoe are made of high-strength alloy cast steel. Two crawler beams are symmetrically arranged, with a 2m wide track shoe. The two crawler beams can be synchronously or separately operated to walk straight and make turns. It is driven by a 4WD walking reducer. It has a built-in planet gear speed reducer which is driven by variable motor.

12. Hydraulic system

Hydraulic system is a closed type and electric proportional pilot variable pump system, which is stable and has a fine-tuning characteristic of speed.

The hydraulic system, with the double-pump confluence function equipped, is driven by two pumps to realize strong power.

The lifting, luffing, and traveling mechanisms are driven by the variable displacement motor. Combination of the variable motor and variable pump control system enables accurate adjustment of working speed, so system gains a fine micro-motion performance. The hydraulic system can realize slow slewing, smooth and reliable transfer, and impact-free start and stop.

13. Oil cylinder assembly

Hydraulic power pins are used for the connections between the boom and the turntable, the frame and the crawler beam, the front turntable and the rear turntable, and the installations of the lifting mechanism, and main/auxiliary winch systems. In addition, the gantry jacking cylinder, connecting beam outrigger cylinder, crawler shoe tensioning cylinder, etc. are configured.

14. Electrical system

Electric system is mainly comprised of following parts: engine control, monitoring instruments, auxiliary devices, hydraulic system control, moment limit and safety monitoring, etc.

Electric system is composed of regular electric system and PLC monitoring system.

Regular electrical system is a 24V multiple circuit, minus earth, single wire system for electric equipment. It includes power source, start control, engine control, status monitoring, cab air conditioner, sound equipment, lighting (lamp), wiper and walkie talkie, etc.

PLC control system works on following systems and movements: winch system, luffing system, slewing system, crane walk, cab rotation and cab overturn, etc. All movements are based on electric-hydraulic proportional control technology and through PLC logic control, which ensure the normal work of all functions.

15. Engine system

Model: SCANIA DC16;
Rated power: 2 × 425 kW/1900rpm;
Max. torque/max. torque speed: 2400Nm/1500rpm;
Type: Straight-line, eight-cylinder, water-cooled, turbo charging intercooler, electronic fuel injection, four-stroke diesel engine;
Environmental protection property: meet EU III or China III emission standard;
Fuel tank capacity: 2 × 1000 L.

16. Counterweight

Counterweight includes vehicle body counterweight, turntable counterweight and lifting counterweight.

Vehicle body counterweight weighs 140 t is installed on the transverse beam, and is composed of counterweight frame 2 × 10t, counterweight block 6 × 10t in front and rear.

Turntable counterweight, weighing 300 t, is installed at the rear side of the turntable and is composed of counterweight tray 1 × 20t, counterweight block 7 × 4 × 10t.

Standard configuration of the counterweight weighs 800 t in total and is composed of:

Luffing counterweight tray: 1 × 30t; side tray 2 × 5t, and counterweight block: 76 × 10t.

17. Hook block

There are 6 hook blocks, see the table below for details:

Name	1400t	900t (*)	900t	650t (*)	450t (*)	330t (*)	100t
Weight (t)	43.8	37.3	16.7	12.1	9.3	8.7	5
Notes			Option				Option

Note: * indicates that it is disassembled from the 1400t hook block.

18. Centralized lubrication system

A progressive centralized lubrication system is used to help fill lubricating oil for thrust wheel, slewing bearing, and main hinge points, ensuring that oil at each lubricating point is sufficient. The one-click operation makes vehicle maintenance to be easy and convenient.

Safety Precautions

This crane has following safety protective functions: setup mode & work mode switchover function, emergency stop function, LMI system, hydraulic system safety protective function, rope discharge protection, lowering limitation, mis-operation function, pawl lock function, slewing lock function, boom backstop function, boom limit angle limitation, hook latch, anti-two block, video monitoring function, audible and visual function, lightning protection. Meanwhile, it is equipped with following devices, such as illuminator, rear view mirror, height lamp, anemometer and level gauge, etc.

1.Setup mode & work mode switchover

In Setup Mode, rope discharge protector, boom limit and LMI are deactivated to facilitate setup; in Work Mode, all safety devices are activated.

2.Emergency stop function

It can quickly stop all movements in case of emergency.

3.LMI system

Detection function: LMI can automatically detect boom angle and lifting load and other parameters.

Display function: crane working parameters, like moment percentage, actual load, rated load, radius, boom length, angle, max. height, OM code, parts of line, limit angle and information code are displayed on 10.4 inches HD LCD, and indicated in Chinese (or English) and graphics.

Warning function: it has completed pre-warning and overload cut-off function. If it has detected that actual load exceeds rated load, boom surpasses limit angle, LMI will give a warning and limit current movement.

This system has a fault self-diagnosis function.

4.Hydraulic system protective function

Hydraulic system is equipped with hydraulic balance valve and hydraulic relief valve, which ensure system stability and safety during working hours.

5.Rope discharge protection function

A rope discharge protector is mounted on boom head to avoid over-discharge of wire rope. When wire rope reaches a certain height, rope discharge protector indicator on display will turn on; meanwhile, lifting movement will automatically halt.

6.Lowering limitation function

Winch systems are equipped with a lowering limiter, which will protect wire rope from being over discharged from winch drum. When only three turns of wire rope are left on winch drum, lowering limiter indicator on display will turn on; meanwhile, falling movement will automatically halt.

7.Misoperation prevention function

Handle has a misoperation prevention function: a safety protection switch is located on front of handle; when this switch is not pressed down, signals of all movements are shielded, handle doesn't work, which avoids misoperation.

8.Pawl (dog) lock function

This machine is equipped with a ratchet locking device, which is designed to lock up luffing winch and make sure boom is in safe placement during non-working hours.

9.Slewing lock function

This crane includes a slewing lock device that locks up slewing movement of superstructure when crane power is off.

10.Boom anti-back-tipping function

A hydraulic anti-back-tipping device is respectively equipped on boom, super lifting device mast, luffing jib and luffing jib support for prevention of overturn.

11.Boom limit angle restricted function

In work mode, when boom luffing reaches the max. operating angle, double control of LMI and travel switch will stop boom-up process; when boom luffing reaches the min. operating angle, due to LMI control, boom-down process will be stopped, accompanied by an audible alarm. The upper limit and lower limit of luffing jib is under the control of angle limit switch.

12.block latch function

All hook blocks are equipped with a safety latch, which prevents hook-mounted sling from coming off.

13.Anti-two block switch function

A suspended anti-two block is located on boom head, when the rising hook block comes into contact with anti-two block, the rising movement will be stopped in order to protect hook rope.

14.Closed-circuit monitoring system

It consists of camera and monitor that respectively monitors elevation winch, main luffing winch, front and rear luffing winch of jib.

15.Audible and visual alarm function

It has a tri-colored bar and an audible and visual alarm, can real time display vehicle load and movement state and can warn the driver and outdoor working staff by flashing and making a sound.

16.Lightning protection

Lightning protection and grounding systems and surge protective devices are optional, which can be equipped to control the risk of lightning stroke.

17.Illuminator

Illuminators are located on the front of turntable, on top of and inside of operator's cab. In the night, illuminators supply lighting.

18.Rearview mirror

Rear-view mirror is out of operator's cab, through which the operator will observe crane rear situation.

19.Height lamp

Height lamp is mounted on top of boom, serving as a kind of high-altitude caution.

20.Anemometer

Its real time detects current wind speed, and transmits it to the monitor of operator's cab, reminding operator to pay attention to wind load safety.

21.Level gauge

This crane is equipped with an electronic and a mechanical level gauge. The level gauge shows degree of road inclination and offers levelness reference to operator.

Main Technical Parameters

1.XLC30000 crawler crane outline drawing

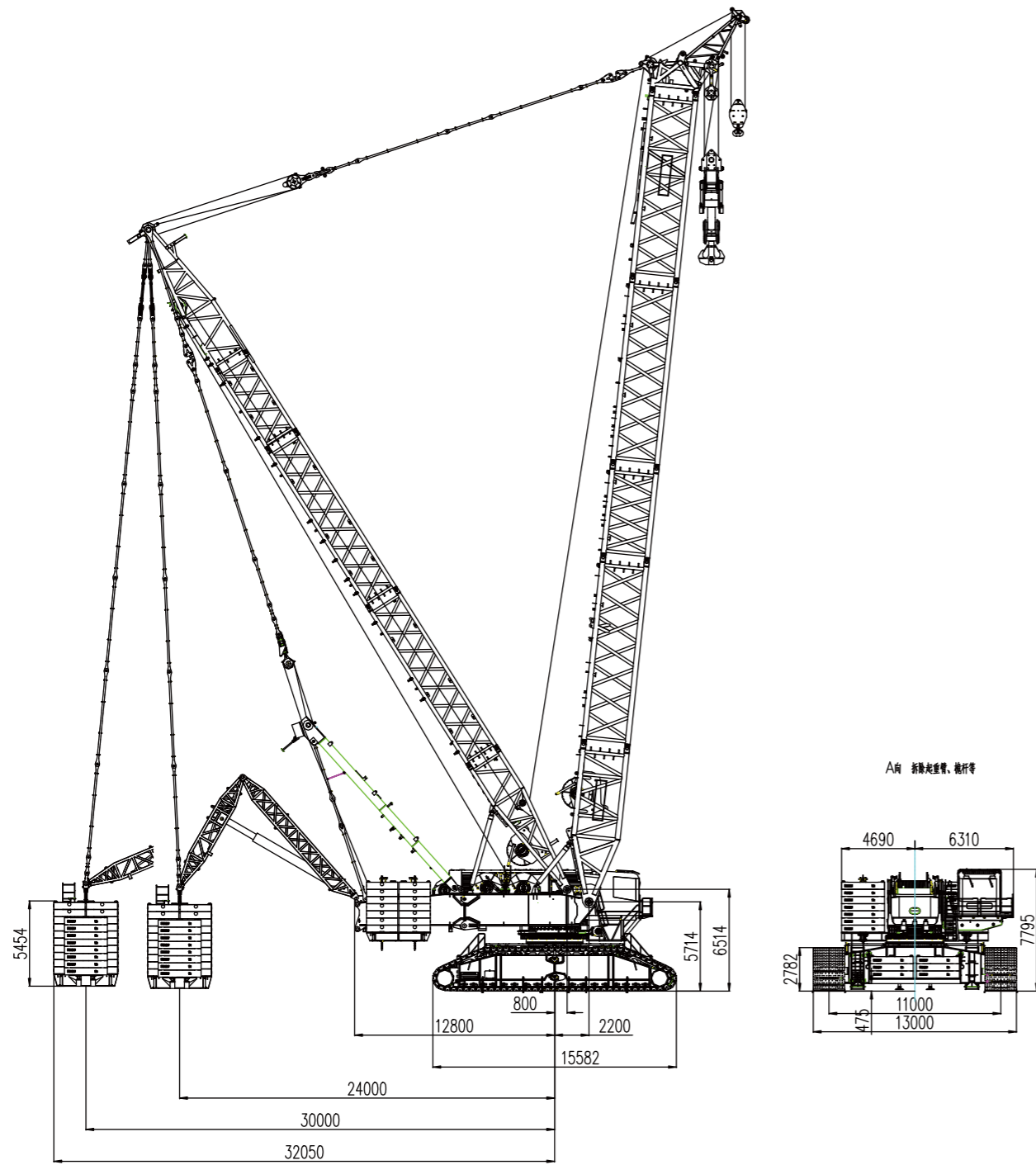

Figure 1 XLC30000 crawler crane outline drawing

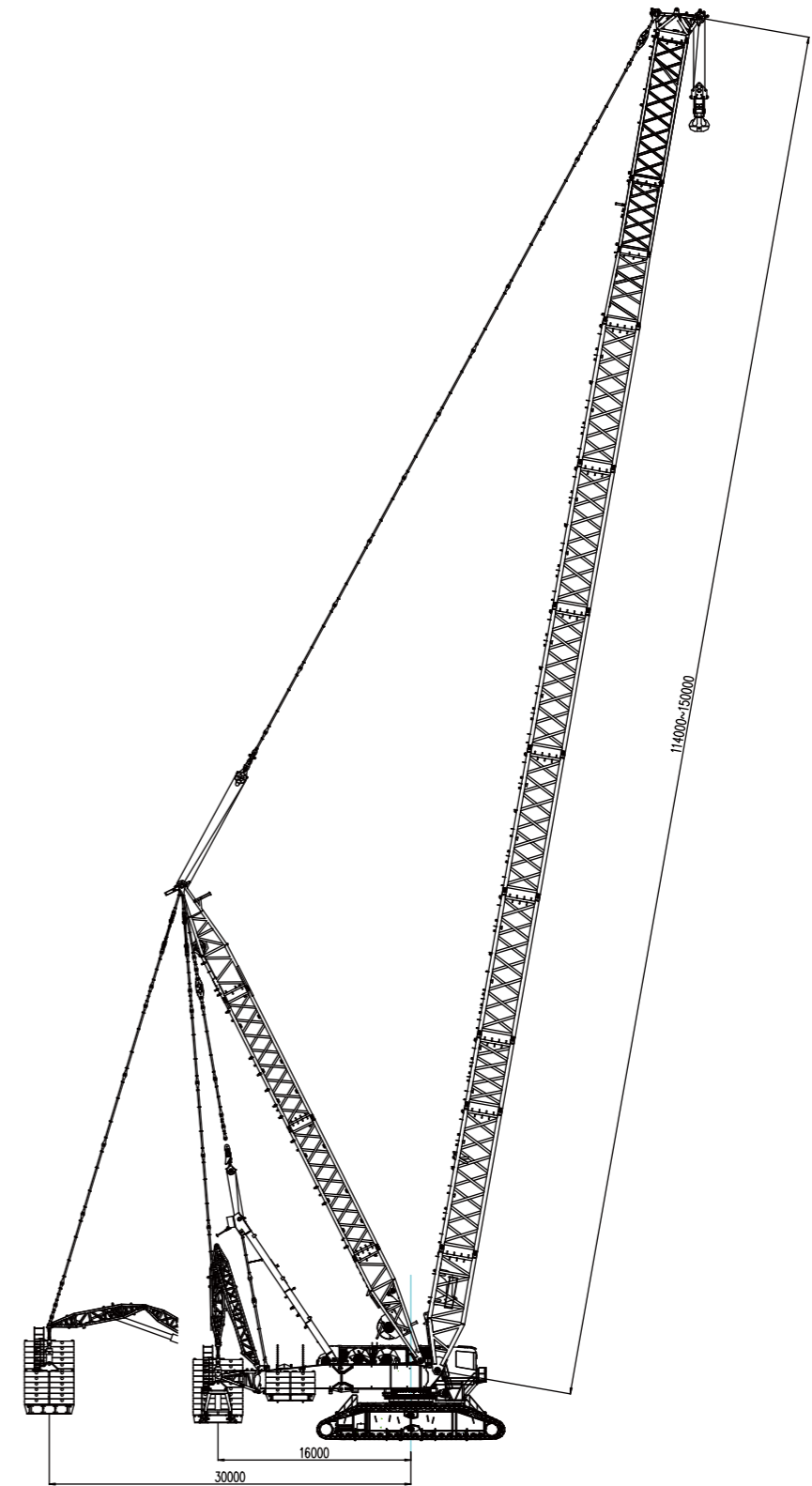

Figure 2 XLC30000 crawler crane outline drawing

Main Technical Parameters

2. Main technical parameters of XLC30000 crawler crane

Item	Unit	Value	
Maximum load moment	t.m	30000	
Max. rated lifting capacity	Heavy-duty boom	t	2000
	Lightweight boom	t	580
	Luffing jib	t	650
	Special jib	t	900
	Fixed jib	t	400
Dimension parameter	Heavy-duty boom length	m	54 ~ 120
	Lightweight boom length	m	114 ~ 168
	Luffing jib length	m	(54~108)+(36~108)
	Special jib length	m	(54~120)+18
	Fixed jib angle	°	20°
	Fixed jib length	m	(114~144)+(12~18)
Speed parameter	Max. single line speed of winch system	m/min	120
	Max. line speed for luffing operation of mast	m/min	2×40
	Max. line speed of boom luffing system	m/min	120
	Max. line speed of luffing jib luffing operation	m/min	105
	Max. slewing speed (no load)	rpm	0.3/0.6
	Max. travel speed	km/h	0.4/0.8
Engine rated power	Kw/rpm	2×425/1900	
Overall weight (54m heavy-duty boom, 1400t hook block)	t	1290	
Average ground pressure	MPa	0.27	
Grade ability (with basic boom)	—	20%	
Max. weight of single part in transport status	t	45	
Max. size of single part (turntable) in transport status (L×W×H)	m	12.4×3.73×3.5	

3. XLC30000 crawler crane OM configurations

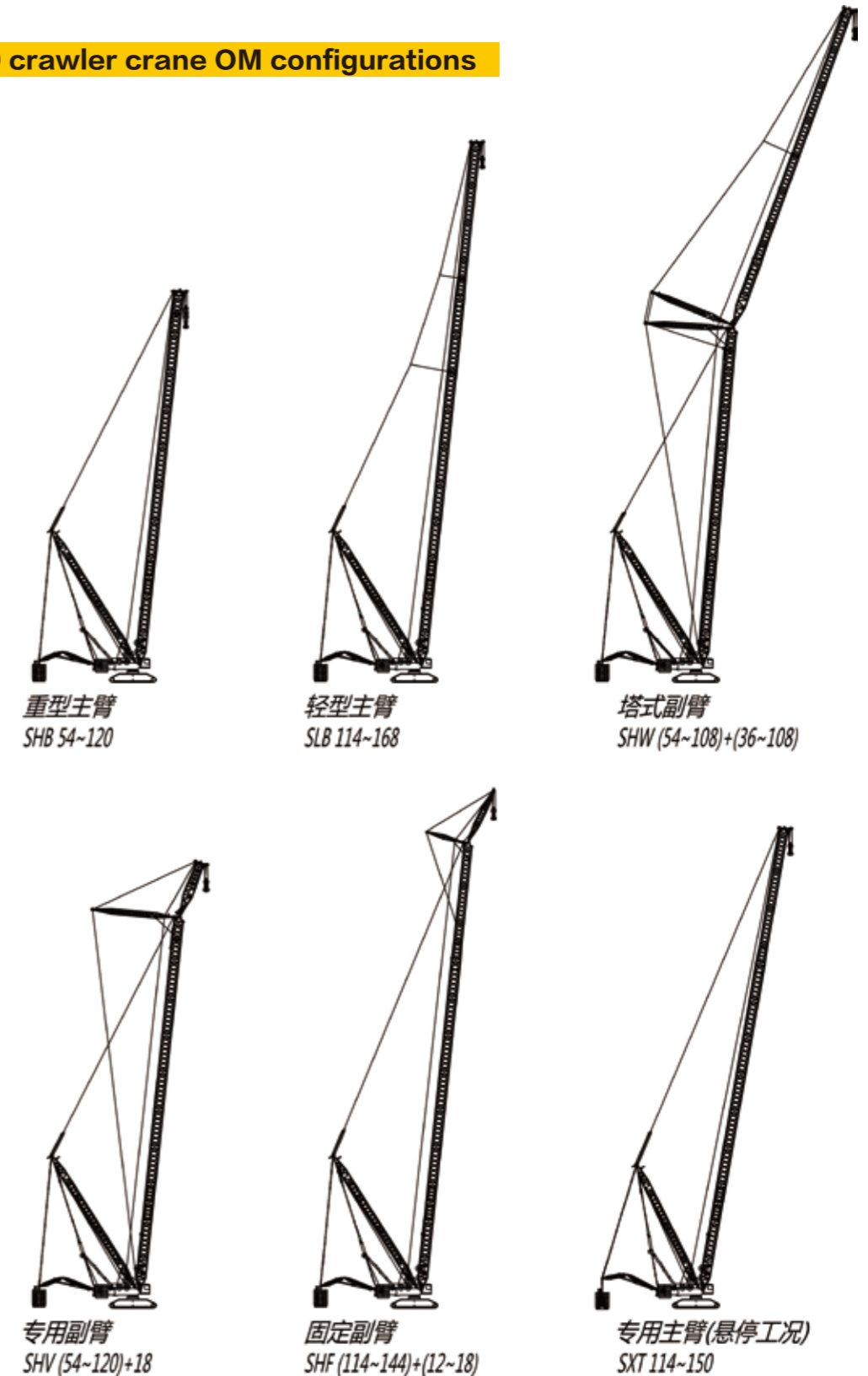

11

XLC30000 CRAWLER CRANE

P12-P13 Heavy-duty boom SHB

P14-P16 Lightweight boom SLB

P17-P28 Luffing jib SHW

P29-P30 Special jib SHV

P31-P33 Fixed jib SHF

P34-P37 Special boom SXT

P38-P39 Strengthened heavy-duty boom SHB-DS

P40-P41 Strengthened lightweight boom SLB-DS

P42-P43 Strengthened special jib SHV-DS

P44-P45 Strengthened fixed jib SLF-DS

Heavy-duty boom SHB

Boom Section Specification	Boom Length (m)	Boom Section Specification	Frame Combination of SHB							Boom head	
			12mA	6mA	6mB	12mB	12mC	12mD	12mE		12mYS
54	1	1	1	1	—	1	—	1	—	—	1
60	1	1	1	1	1	1	—	1	—	—	1
66	1	1	1	1	—	1	—	1	1	—	1
72	1	1	1	1	1	1	—	1	1	—	1
78	1	1	1	1	—	1	—	1	2	—	1
84	1	1	1	1	1	1	—	1	2	—	1
90	1	1	1	1	—	1	1	1	2	—	1
96	1	1	1	1	1	1	1	1	2	—	1
102	1	1	1	1	—	1	2	1	2	—	1
108	1	1	1	1	1	1	2	1	2	—	1
114	1	1	1	1	—	1	2	1	2	1	1
120	1	1	1	1	1	1	2	1	2	1	1

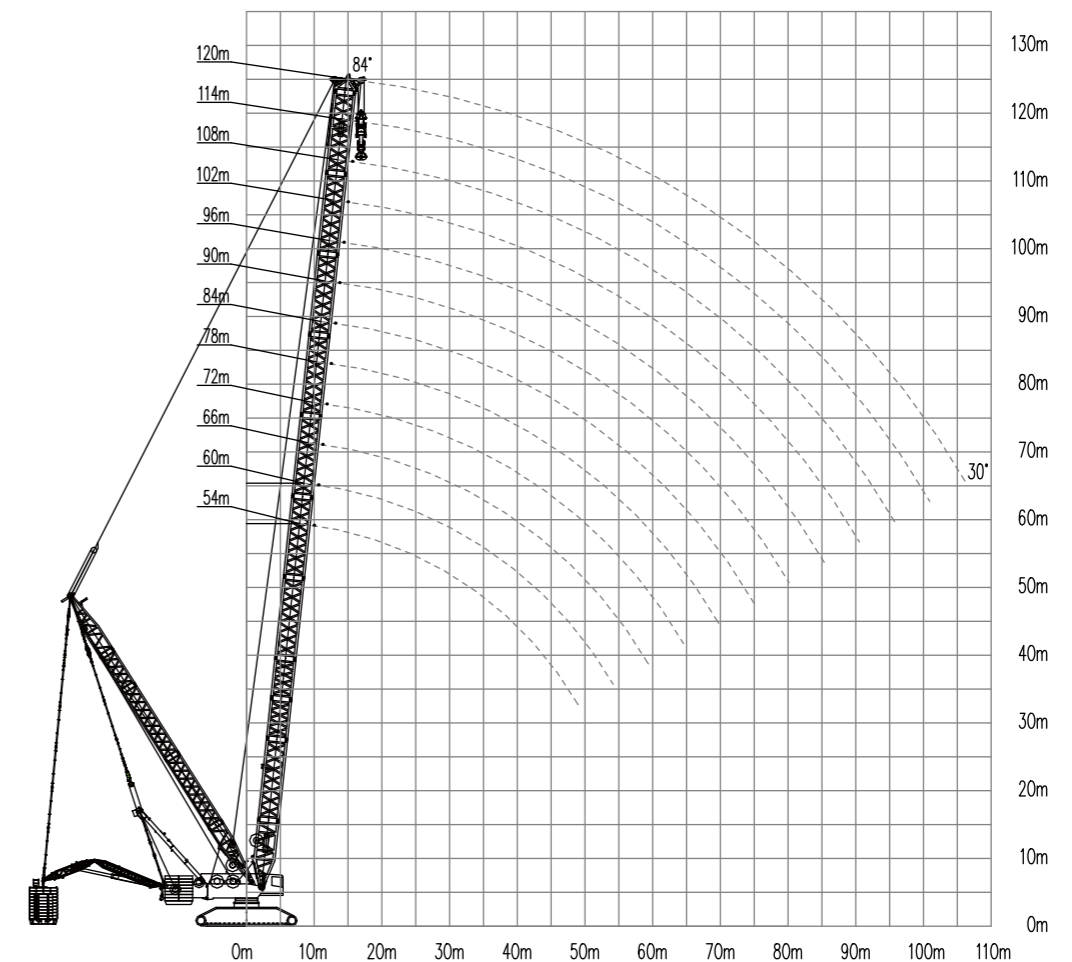

Schematic diagram for XLC30000 heavy-duty boom working range in OM SHB

Lifting Performance Table for Classic OMs

Lifting performance table for XLC30000 Heavy-duty boom SHB

Luffing mast radius 26 m, luffing counterweight 800 t, luffing counterweight radius 30 m, turntable counterweight 300 t, vehicle body counterweight 140 t

Radius (m)	Boom Length (m)											
	54*	60	66	72	78	84	90	96	102	108	114	120
12	2000	1566	1474	1380								
14	1882	1566	1474	1380	1264	1081	964					
16	1850	1566	1474	1380	1264	1081	964	849	741	643		
18	1529	1542	1474	1380	1264	1081	964	849	741	643	577	518
20	1348	1382	1380	1377	1264	1081	964	849	741	643	577	518
22	1202	1234	1249	1246	1243	1081	964	849	741	643	577	518
24	1088	1111	1139	1136	1134	1081	964	849	741	643	577	518
26	987	1014	1038	1040	1037	1034	964	849	741	643	577	518
28	901	926	953	958	955	952	950	849	741	643	577	518
30	827	850	875	887	885	881	879	849	741	643	577	518
32	762	784	807	825	823	819	818	814	741	643	577	518
34	705	726	748	766	768	764	763	760	741	643	577	518
36	654	674	695	712	720	716	715	711	708	643	577	518
38	609	628	648	664	677	673	672	668	665	643	577	518
40	567	587	605	621	634	634	633	629	626	629	577	518
44	496	515	532	546	559	567	566	562	559	562	559	518
48	434	454	471	484	496	504	509	507	504	506	504	500
52		401	418	431	443	450	459	457	456	459	457	453
56			373	386	397	404	413	415	414	417	416	412
60			331	346	357	364	373	378	377	381	379	376
64				309	321	329	337	342	346	349	347	344
68					289	297	306	311	315	321	320	316
72						269	278	283	287	295	295	292
76							242	252	257	262	270	270
80								228	234	239	247	250
84									213	218	226	232
88										199	207	213
92											189	194
96												177
100												
106												

2.Lightweight boom SLB

Boom Section Specification	Frame Combination of SLB											
	12mA	6mA	6mB	12mB	12mC	12mE	12mYS	TB 12mS	TB 6mGD	TB 6m	TB 12mA	TB 12mB
114	1	1	—	1	2	1	—	1	1	1	—	1
120	1	1	—	1	2	1	—	1	1	—	—	2
126	1	1	—	1	2	2	—	1	1	1	—	1
132	1	1	1	1	2	2	—	1	1	1	—	1
138	1	1	1	1	2	2	—	1	1	—	1	1
144	1	1	1	1	2	2	—	1	1	1	1	1
150	1	1	1	1	2	2	—	1	1	—	1	2
156	1	1	1	1	2	2	—	1	1	1	1	2
162	1	1	1	1	2	2	1	1	1	—	1	2
168	1	1	1	1	2	2	1	1	1	1	1	2

Lifting Performance Table for Classic OMs

Schematic diagram for XLC30000 lightweight boom working range in SLB

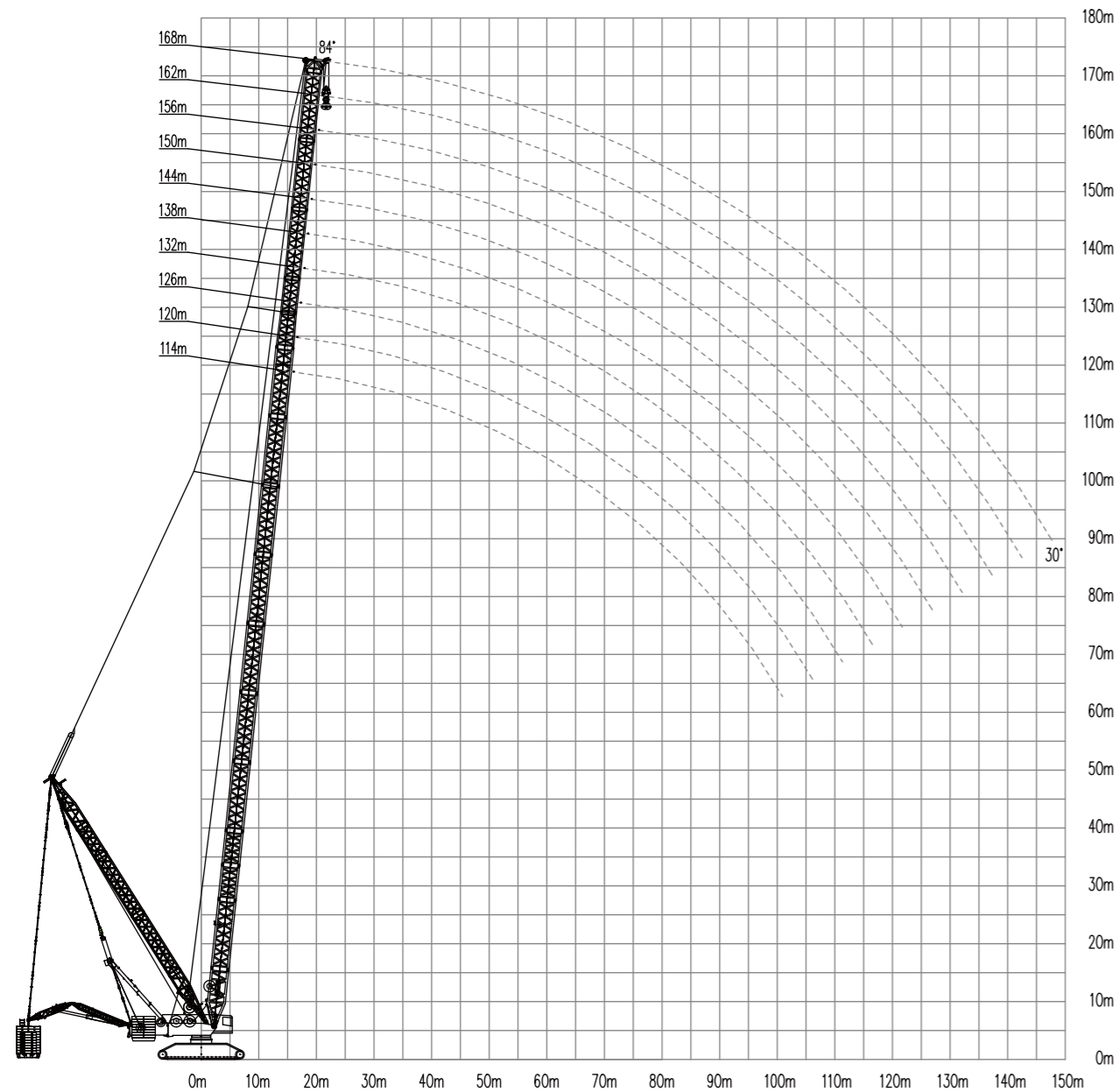

Lifting performance table for XLC30000 lightweight boom SLB

Luffing mast radius 26 m, luffing counterweight 800 t, luffing counterweight radius 30 m, turntable counterweight 300 t, vehicle body counterweight 140 t

Radius (m)	Boom Length (m)									
	114	120	126	132	138	144	150	156	162	168
18	588	522	467	423						
20	588	522	467	423	379	339	305			
22	588	522	467	423	379	339	305	274	252	227
24	588	522	467	423	379	339	305	274	252	227
26	588	522	467	423	379	339	305	274	252	227
28	588	522	467	423	379	339	305	274	252	227
30	588	522	467	423	379	339	305	274	252	227
32	588	522	467	423	379	339	305	274	252	227
34	588	522	467	423	379	339	305	274	252	227
36	588	522	467	423	379	339	305	274	252	227
38	588	522	467	423	379	339	305	274	252	227
40	588	522	467	423	379	339	301	273	252	227
44	575	519	464	422	379	333	294	270	251	226
48	520	513	459	418	376	326	287	268	249	224
52	473	471	454	413	369	319	280	262	246	221
56	432	431	426	408	362	312	273	256	243	219
60	397	396	391	387	355	305	266	251	240	216
64	366	365	360	356	349	298	260	245	237	213
68	338	337	333	330	326	291	254	240	234	210
72	313	313	308	305	302	268	237	235	231	207
76	291	291	286	283	280	247	218	230	228	205
80	268	271	266	263	260	229	201	226	217	201
84	248	251	248	245	242	213	186	210	200	198
88	229	233	232	228	226	198	172	194	184	188
92	211	215	214	214	210	186	160	179	169	172
96	195	199	198	199	194	174	149	166	156	158
100	179	184	184	184	180	164	139	155	144	145
108			157	157	155	147	122	135	124	123
116				133	132	134	109	119	108	105
124						114	98.8	106	94.3	90.8
132							91.4	96.7	83.3	78.4
140									74.8	68.3
148										60.2

Lifting Performance Table for Classic OMs

3.Luffing jib SHW

Boom Section Specification	Luffing Jib Combination of SHW									
	Boom Length (m)	Boom Base Section	TB 12mS	TB 6mGD	TB 6m	TB 12mA	TB 12mB	TB 12mC	TB 12mD	Boom Head
36	1	—	1	1	—	—	—	—	1	1
42	1	1	1	—	—	—	—	—	1	1
48	1	1	1	1	—	—	—	—	1	1
54	1	1	1	—	1	—	—	—	1	1
60	1	1	1	1	1	—	—	—	1	1
66	1	1	1	—	1	1	—	—	1	1
72	1	1	1	1	1	1	—	—	1	1
78	1	1	1	—	1	2	—	—	1	1
84	1	1	1	1	1	2	—	—	1	1
90	1	1	1	—	1	3	—	—	1	1
96	1	1	1	1	1	3	—	—	1	1
102	1	1	1	—	1	3	1	—	1	1
108	1	1	1	1	1	3	1	—	1	1

Schematic diagram for XLC30000 luffing jib SHW

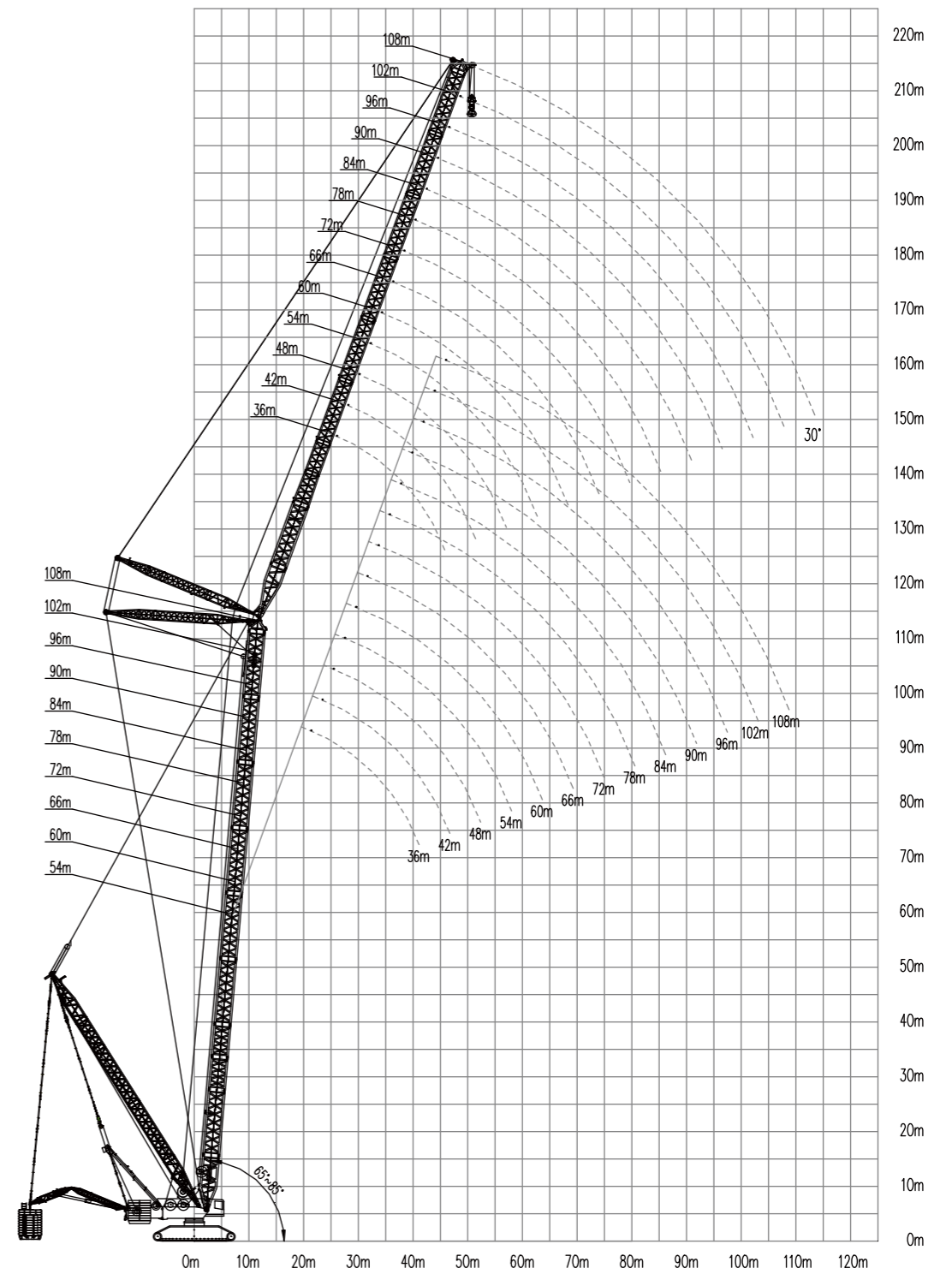

Lifting Performance Table for Classic OMs

Lifting performance table of XLC30000 luffing jib SHW

Boom length 54m Boom angle 85°
 Luffing counterweight radius 30m Luffing counterweight 510t
 Central counterweight 140t Turntable counterweight 300t

Luffing Jib Length (m)													
Radius (m)	36	42	48	54	60	66	72	78	84	90	96	102	108
22	684												
24	669	599											
26	655	583	537										
28	618	568	529	474									
30	557	554	521	464	438								
32	509	520	508	455	438	381							
34	461	476	490	447	438	381	352						
36	427	437	459	438	411	361	352	300					
38	392	404	421	429	406	353	333	297	268				
40	366	375	393	402	391	345	330	294	267	230			
44		328	343	349	353	328	325	288	264	230	208	177	
48			303	308	311	308	306	281	260	227	206	175	167
52			267	274	277	274	274	270	255	224	204	173	156
56				246	248	247	246	243	240	220	202	170	154
60					224	222	222	218	215	216	199	168	152
64					202	202	201	198	194	195	190	166	150
68						184	183	180	177	178	175	163	149
72							168	165	162	162	159	158	147
76								150	148	148	145	143	140
80									137	135	136	133	128
84										125	126	122	117
88											115	112	110
92												105	102
96													99.5
96												96.4	94.9
100													91.5
100													87.7
104													84.1
104													77.6
108													71.8

Lifting performance table of XLC30000 luffing jib SHW

Boom length 60m Boom angle 85°
 Luffing counterweight radius 30m Luffing counterweight 510t
 Central counterweight 140t Turntable counterweight 300t

Luffing Jib Length (m)													
Radius (m)	36	42	48	54	60	66	72	78	84	90	96	102	108
22	644												
24	644	551											
26	602	538											
28	580	525	488										
30	543	510	480	438									
32	507	498	472	438	409								
34	470	485	464	414	385	341							
36	435	446	445	406	381	338	322						
38	399	411	421	398	376	332	322	277					
40	370	381	398	389	371	325	322	274	261				
44		332	348	358	353	310	302	268	247	218	199		
48			306	316	322	296	296	262	244	215	199	167	150
52				272	282	285	277	282	255	240	212	199	165
52					253	257	252	259	249	235	208	199	163
56						252	259	249	235	208	199	163	148
60							232	230	233	226	224	203	199
60								204	209	211	205	205	199
64									190	193	186	186	184
68										173	171	170	169
72											173	171	170
72												169	167
76													153
76													149
80													141
80													139
84													134
84													124
88													114
88													114
92													105
92													105
96													97.5
96													97.5
100													89.7
100													89.7
104													81.9
104													81.9
108													72.8

Lifting Performance Table for Classic OMs

Lifting performance table of XLC30000 luffing jib SHW

Boom length	66m	Boom angle	85°
Luffing counterweight radius	30m	Luffing counterweight	510t
Central counterweight	140t	Turntable counterweight	300t

Radius (m)	Luffing Jib Length (m)															
	36	42	48	54	60	66	72	78	84	90	96	102	108			
24	584															
26	584	523														
28	553	495	461													
30	527	483	461	409												
32	495	470	461	409	381											
34	463	457	438	409	381	325										
36	433	430	430	383	359	322	295									
38	404	405	408	376	354	318	294	262								
40	376	380	387	368	350	311	291	261	238							
44		335	345	347	340	299	286	256	235	209	199					
48		296	308	313	310	286	280	249	232	206	188	167	145			
52			274	282	282	269	273	243	228	202	186	167	144			
56				253	256	246	254	237	224	198	183	156	143			
60					232	225	234	226	220	193	181	154	141			
64					208	205	215	210	206	189	178	151	139			
68						187	196	192	190	185	175	149	137			
72							176	176	173	174	166	147	136			
76								151	161	158	160	156	145	134		
80									141	145	146	143	139	131		
84										131	135	131	130	124		
88											123	121	120	116		
92												108	110	107		
96													101	102	98.9	
100														92.8	91.3	
104															81.5	84.1
108																74.8
110																69.7

Lifting performance table for XLC30000 luffing Jib SHW

Boom length	72m	Boom angle	85°
Luffing counterweight radius	30m	Luffing counterweight	510t
Central counterweight	140t	Turntable counterweight	300t

Radius (m)	Luffing Jib Length (m)																
	36	42	48	54	60	66	72	78	84	90	96	102	108				
24	524																
26	518	461															
28	506	456	419														
30	496	445	415	381													
32	484	433	408	381	352												
34	454	423	402	381	352	298											
36	426	412	395	354	332	298	272										
38	400	396	387	347	328	294	272	246									
40	375	373	375	340	323	290	270	243	230								
44		330	336	326	314	281	265	238	230	199	178						
48		293	301	307	302	269	259	231	215	199	175	151	137				
52			269	277	275	257	253	225	211	188	173	149	136				
56				250	250	244	247	219	208	184	171	147	134				
60					225	228	223	228	213	204	180	168	145	133			
64						207	204	210	203	199	176	166	143	131			
68							186	193	188	185	171	163	141	129			
72								178	174	172	167	160	138	127			
76									155	161	160	157	150	136	125		
80										144	147	146	141	133	123		
84											134	136	132	125	117		
88												117	126	123	117	110	
92													110	113	110	103	
96														102	103	97.2	
100															94.3	91.2	
104																83.1	85.5
108																	76.4
110																	71.3

Lifting Performance Table for Classic OMs

Lifting of performance table of XLC30000 luffing jib SHW

Boom length 78m Boom angle 85°
 Luffing counterweight radius 30m Luffing counterweight 510t
 Central counterweight 140t Turntable counterweight 300t

Luffing Jib Length (m)													
Radius (m)	36	42	48	54	60	66	72	78	84	90	96	102	108
24	485												
26	481	433											
28	470	424	398										
30	460	415	398	352									
32	450	405	398	352	322								
34	438	395	373	352	322	292							
36	412	383	366	332	322	292	261						
38	388	373	360	325	304	275	261	231					
40	365	363	353	319	301	271	261	228	208				
44		332	334	304	293	263	247	223	205	183			
48		297	301	291	284	253	242	217	202	180	167	143	
52			271	273	270	244	236	211	198	177	167	142	134
56				247	246	233	230	205	194	173	167	140	134
60				225	225	223	223	199	190	169	158	138	127
64					205	205	207	192	186	165	155	136	125
68						188	191	185	180	161	153	133	123
72						173	176	172	168	156	150	131	121
76							159	159	156	151	144	128	119
80								146	145	141	135	125	117
84									134	131	126	118	112
88									117	122	118	110	105
92										111	110	103	99.2
96											102	97.1	93
100												89.7	87.2
104													84.1
108													
110													

Lifting performance table for XLC30000 luffing jib SHW

Boom length 84m Boom angle 85°
 Luffing counterweight radius 30m Luffing counterweight 510t
 Central counterweight 140t Turntable counterweight 300t

Luffing Jib Length (m)													
Radius (m)	36	42	48	54	60	66	72	78	84	90	96	102	108
26	461												
28	431	398											
30	422	398	356										
32	412	372	349	322									
34	402	363	343	322	292								
36	392	353	337	322	292	261							
38	383	343	331	300	292	261	235						
40	364	334	324	294	292	261	233	210					
44	325	318	311	281	269	243	228	206	199	169			
48		291	294	267	261	234	223	201	186	167	152	134	
52			266	257	253	226	217	195	183	164	150	134	121
56				245	240	217	211	189	179	160	148	134	120
60				224	220	210	206	183	175	155	145	134	117
64					201	202	200	177	171	152	143	126	116
68						188	185	171	168	148	140	124	114
72							174	171	165	160	144	137	121
76								158	153	149	139	135	119
80									142	139	135	132	115
84										129	128	123	111
88											120	119	115
92												111	108
96													101
100													91.8
104													85.1
108													79.5
112													71.9

Lifting Performance Table for Classic OMs

Lifting performance table for XLC30000 luffing jib SHW

Boom length 90m Boom angle 85°
 Luffing counterweight radius 30m Luffing counterweight 510t
 Central counterweight 140t Turntable counterweight 300t

Radius (m)	Luffing Jib Length (m)															
	36	42	48	54	60	66	72	78	84	90	96	102	108			
26	404															
28	395	358														
30	385	349	324													
32	376	341	319	290												
34	367	333	314	287	265											
36	358	324	309	282	262	237										
38	349	316	303	277	259	234	216									
40	338	307	297	270	255	231	214	199								
44	303	292	285	259	247	224	209	199	174	154						
48		276	274	247	239	217	204	185	171	153	140	124				
52			252	237	230	209	199	180	167	150	138	123	112			
56			230	227	223	201	194	174	164	147	135	121	110			
60				213	212	192	188	168	160	143	133	119	108			
64					195	186	183	163	156	139	130	116	107			
68						179	177	158	153	136	128	113	105			
72							165	164	152	149	132	125	111	103		
76								152	147	142	128	123	108	101		
80									136	133	124	120	106	100		
84										127	124	120	114	103	98.4	
88											115	114	107	99.5	94	
92												107	100	94.9	88.2	
96													94.1	88.9	82.7	
100														88.2	83.3	77.5
104															78.1	72.6
108																68
112																63.7

Lifting performance table for XLC30000 luffing jib SHW

Boom length 96m Boom angle 85°
 Luffing counterweight radius 30m Luffing counterweight 510t
 Central counterweight 140t Turntable counterweight 300t

Radius (m)	Luffing Jib Length (m)																
	36	42	48	54	60	66	72	78	84	90	96	102	108				
26	381																
28	360	324															
30	351	321	297														
32	343	313	293	265													
34	334	305	289	263	241												
36	326	298	283	259	239	230											
38	318	291	277	253	238	216	199										
40	311	283	271	248	234	213	199	178									
44	288	269	260	238	226	206	199	174	167	144							
48		257	250	227	219	199	187	169	156	140	134	114					
52			235	217	211	191	182	165	153	138	127	112	102				
56				215	209	204	184	176	160	149	134	124	110	101			
60					197	197	177	171	154	146	131	121	108	100			
64						181	171	166	148	142	127	119	106	98.4			
68							165	162	143	139	124	116	104	96.4			
72								154	153	139	135	120	114	102	94.6		
76									142	134	131	116	111	100	92.8		
80										129	124	112	109	97.4	90.9		
84											120	116	109	106	94.9	89.2	
88												108	106	103	91.8	86.9	
92													101	96.8	88.7	84.1	
96														94.8	90.7	85.6	80.4
100															85.1	82.1	74.8
104																77.1	70.6
108																	66.2
112																	62.1

Lifting Performance Table for Classic OMs

Lifting performance table for XLC30000 luffing jib SHW

Boom length 102m Boom angle 85°
 Luffing counterweight radius 30m Luffing counterweight 510t
 Central counterweight 140t Turntable counterweight 300t

Radius (m)	Luffing Jib Length (m)													
	36	42	48	54	60	66	72	78	84	90	96	102	108	
26	352													
28	329	300												
30	322	293	273											
32	313	286	268	245										
34	305	280	263	241	230									
36	298	272	258	237	230	201								
38	291	266	253	231	217	198	181							
40	288	259	248	227	213	194	180	167						
44	267	248	238	218	206	188	175	167	145					
48		237	228	208	199	182	170	154	143	134	117			
52			220	200	192	175	165	150	139	126	115	103	93.8	
56			202	191	185	168	160	145	135	123	113	101	92.8	
60				184	180	162	155	140	132	120	110	99.5	91	
64					167	156	151	136	128	116	108	97.4	89.2	
68					155	150	146	131	125	112	105	94.9	87.4	
72						143	141	127	121	109	103	92.8	85.6	
76							131	122	118	106	100	90.2	83.6	
80								117	115	103	98.4	87.7	82	
84								110	108	100	95.8	85.6	80	
88									100	96.9	93.3	83.1	77.9	
92										92.2	89	80.5	75.9	
96											86.5	83.4	77.9	73.7
100												78.3	75.4	71
104													71.2	66.6
108														62.5
112														58.8

Lifting performance table for XLC30000 luffing jib SHW

Boom length 108m Boom angle 85°
 Luffing counterweight radius 30m Luffing counterweight 510t
 Central counterweight 140t Turntable counterweight 300t

Radius (m)	Luffing Jib Length (m)															
	36	42	48	54	60	66	72	78	84	90	96	102	108			
28	298															
30	292	265														
32	285	260	243													
34	279	255	239	218												
36	272	249	234	214	199											
38	266	244	229	211	199	177										
40	260	238	225	207	199	176	167									
44	249	226	215	199	187	171	167	143	134							
48		217	207	190	180	165	154	139	134	116	106					
52		206	200	182	173	159	149	135	126	113	105	93.8	84.6			
56			185	175	167	153	144	131	122	110	102	92.3	83.8			
60				169	162	147	140	127	119	107	100	90.2	82.3			
64					156	142	135	123	115	104	97.9	87.7	80.6			
68					144	137	131	117	111	102	95.1	85.6	78.6			
72						132	127	114	108	98.4	92.5	83.1	76.4			
76							119	110	105	95.4	90	80.5	74.3			
80								111	106	102	92.3	87.3	77.9	72.4		
84									100	98.3	89.7	84.6	75.9	70.6		
88										91.7	86.6	82.4	73.3	68.7		
92											83.5	80.1	71.3	66.6		
96												78.3	75	68.7	64.9	
100													70.3	66.6	63.2	
104														63.6	60	
108															59.7	56.2
112																52.7
114																51.1

4.Special jib SHV

Schematic diagram for XLC30000 special jib working range in OM SHV

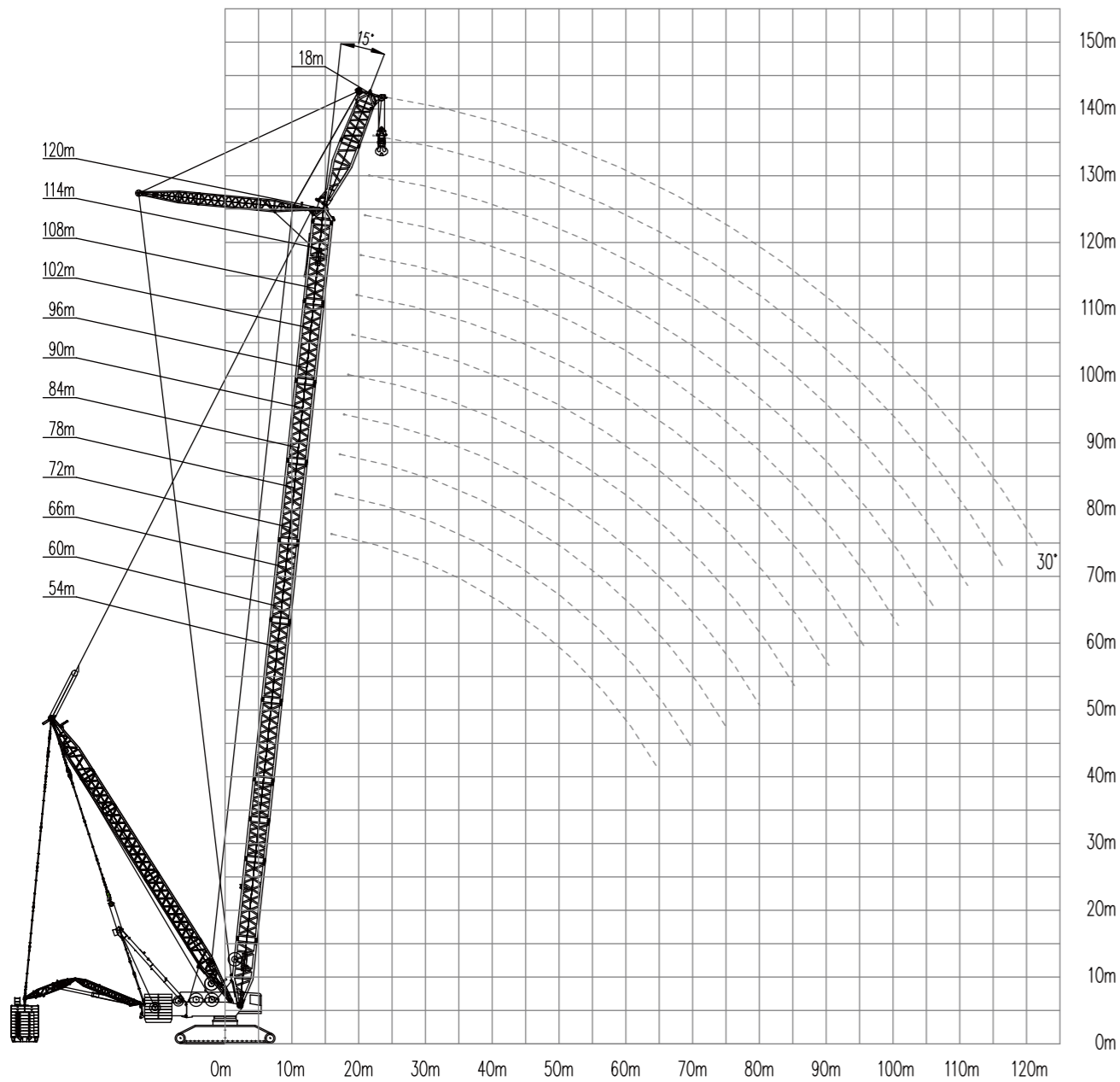

Lifting performance table for XLC30000 special jib SHV

Mast radius 26 m, luffing counterweight 800 t, luffing counterweight radius 30 m, turntable counterweight 300 t, vehicle body counterweight 140 t, jib 18 m

Radius (m)	Boom length (m)												
	54	60	66	72	78	84	90	96	102	108	114	120	
16	900												
18	900	900	900										
20	900	900	900	900	809	730							
22	900	900	900	900	809	730	646	576	514	462			
24	900	900	900	900	809	730	646	576	514	462	411	372	
26	839	847	900	900	809	730	646	576	514	462	411	372	
28	803	814	900	900	809	730	646	576	514	462	411	372	
30	770	783	835	846	809	730	646	576	514	462	411	372	
32	740	755	806	818	809	730	646	576	514	462	411	372	
34	712	729	757	769	767	730	646	576	514	462	411	372	
36	666	689	704	719	717	712	646	576	514	462	411	372	
38	622	643	661	674	672	667	646	576	514	462	411	372	
40	582	601	618	634	631	627	625	576	514	462	411	372	
44	512	529	544	558	562	557	556	553	514	462	411	372	
48	454	469	483	495	504	499	498	494	492	462	411	372	
52	404	418	430	441	450	450	449	445	443	439	411	372	
56	361	374	385	395	404	408	407	403	401	397	402	369	
60	322	335	346	355	363	368	370	367	364	361	358	358	
64	287	300	311	320	327	332	337	335	332	329	326	323	
68		269	280	288	296	300	305	307	304	301	298	295	
72		239	251	260	267	271	276	279	279	275	273	269	
76			225	234	241	246	251	254	256	253	251	247	
80				210	218	222	227	230	233	232	230	227	
84					196	201	206	209	212	213	211	208	
88					174	181	186	189	193	194	194	191	
92						161	168	171	175	176	178	175	
96							150	154	158	159	162	160	
100								138	142	144	147	147	
108									113	116	119	119	
116											93.9	94.2	
124												69.4	

Lifting Performance Table for Classic OMs

5.Fixed jib SHF

Schematic diagram for XLC30000 fixed jib working range in OM SHF

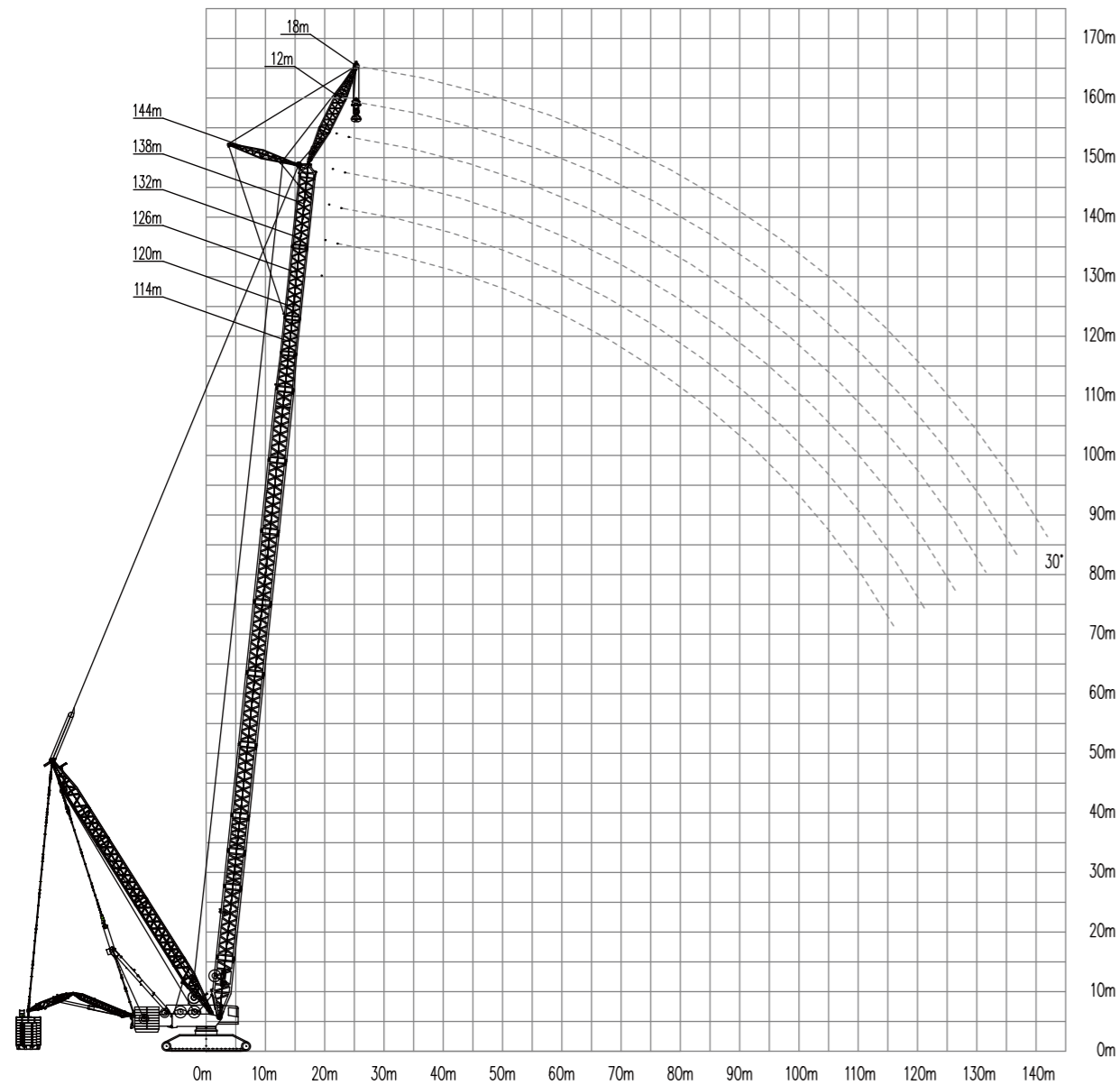

Lifting performance table for XLC30000 fixed jib SHF

Jib length 12 m

Turntable counterweight 300t; vehicle body counterweight: 140t

Mast radius 26 m, luffing counterweight 670t, luffing counterweight radius 30 m

Radius (m)	Boom length (m)					
	114	120	126	132	138	144
20	400					
22	400	386	362	334		
24	400	384	362	334	301	270
26	400	382	362	334	298	270
28	400	380	362	334	296	269
30	400	377	362	334	292	264
32	400	374	360	334	287	262
34	399	372	359	334	283	258
36	395	369	357	334	278	253
38	394	366	356	334	274	249
40	391	363	354	334	269	245
44	386	358	351	334	257	237
48	381	353	349	334	250	229
52	376	348	346	334	242	221
56	372	343	343	332	233	214
60	345	338	338	330	225	207
64	317	315	311	307	217	201
68	293	291	286	282	210	194
72	271	269	264	261	204	188
76	252	250	245	241	198	182
80	234	232	227	224	193	177
84	218	217	212	208	188	172
88	204	202	197	193	184	168
92	190	189	184	180	177	164
96	178	177	172	168	165	161
100	167	166	161	157	154	152
108	142	144	141	137	134	132
116		122	121	120	117	115
124				102	100	100
132					82.9	83.6

Lifting Performance Table for Classic OMs

Lifting performance table for XLC30000 fixed jib SHF

Jib length 18 m

Turntable counterweight 300t; vehicle body counterweight: 140t

Mast radius 26 m, luffing counterweight 670t, luffing counterweight radius 30 m

Boom length (m)						
Radius (m)	114	120	126	132	138	144
24	310	293	285			
26	310	290	280	272	241	220
28	310	290	278	271	236	216
30	307	285	278	266	232	214
32	304	280	278	265	232	211
34	301	280	276	265	225	207
36	299	277	275	265	221	204
38	296	275	273	264	217	201
40	294	272	271	263	214	197
44	288	267	268	260	206	190
48	281	262	265	257	198	185
52	279	257	260	255	190	178
56	274	253	257	252	183	171
60	270	249	255	249	177	165
64	267	246	252	247	171	159
68	262	244	249	245	166	154
72	259	238	246	242	161	149
76	255	236	243	240	156	145
80	237	233	230	227	152	141
84	221	219	214	211	148	137
88	206	205	200	196	145	134
92	193	191	187	183	142	131
96	181	179	174	171	139	128
100	170	168	163	160	137	126
108	147	148	143	139	133	122
116	125	128	126	122	119	117
124		108	107	107	104	102
132				90.5	88.3	88.6
140						72.3

6.Special boom SXT

Boom Section Specification	Frame Combination of SXT										
	12mA	6mA	6mB	12mB	12mC	12mE	TB 12mS	TB 6mGD	TB 6m	TB 12mA	TB 12mB
114	1	1	—	1	2	1	1	1	1	—	1
120	1	1	—	1	2	1	1	1	—	—	2
126	1	1	—	1	2	2	1	1	1	—	1
132	1	1	1	1	2	2	1	1	1	—	1
138	1	1	1	1	2	2	1	1	—	1	1
144	1	1	1	1	2	2	1	1	1	1	1
150	1	1	1	1	2	2	1	1	—	1	2

Lifting Performance Table for Classic OMs

Schematic diagram for XLC30000 special boom working range in OM SXT

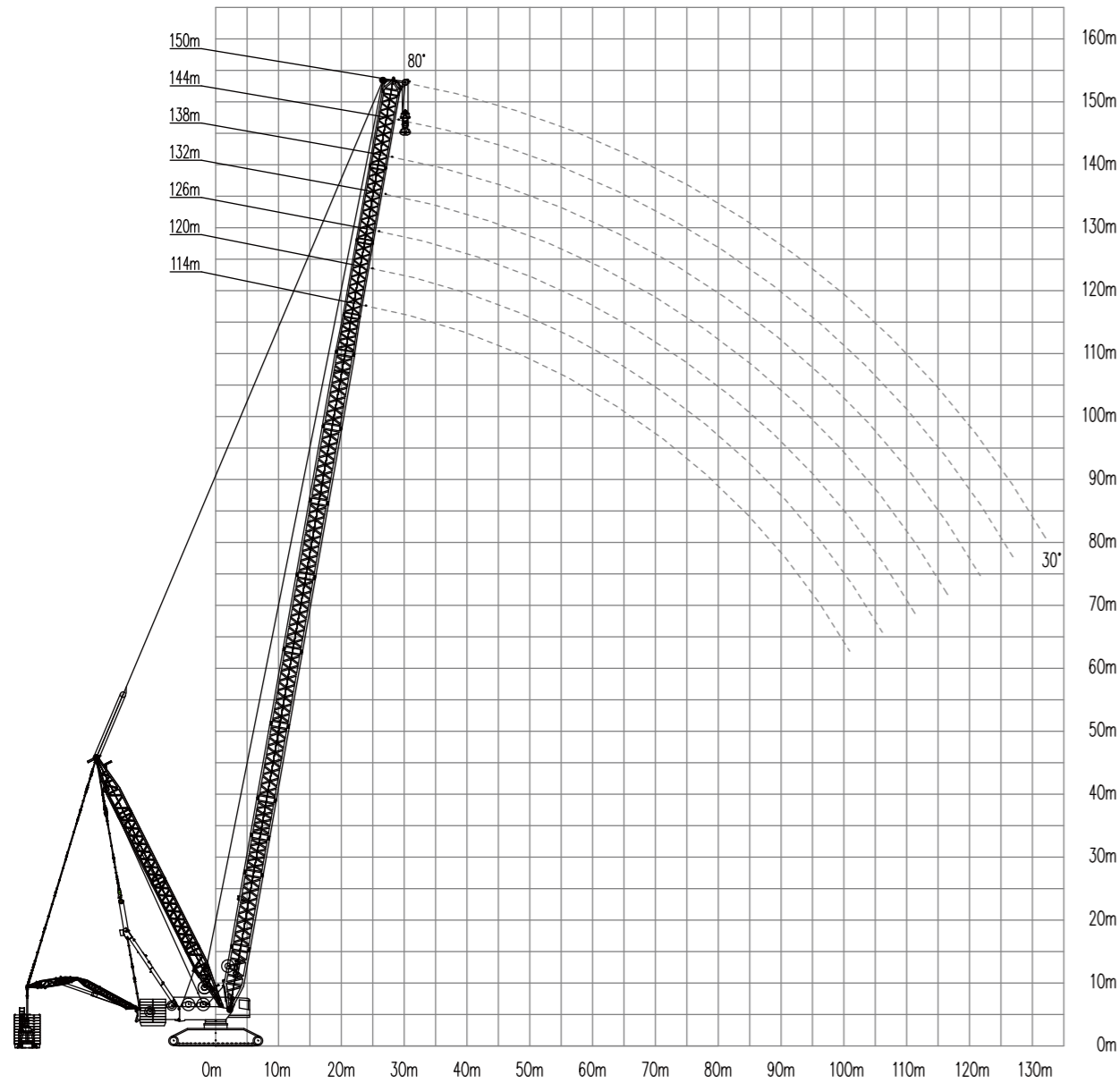

Lifting performance table for XLC30000 special boom SXT

Luffing mast radius 19m, luffing counterweight 480t, luffing counterweight radius 30 m, turntable counterweight 180t, vehicle body counterweight 140 t

		Boom Length (m)						
Radius (m)	114	120	126	132	138	144	150	
24	488							
26	488	430						
28	488	430	385	347				
30	488	430	385	347	309	275		
32	488	430	385	347	309	275	246	
34	488	430	385	347	309	275	246	
36	459	430	385	347	309	275	246	
38	430	428	385	347	309	275	246	
40	404	402	385	347	309	275	246	
44	359	357	354	346	309	274	245	
48	322	320	316	312	308	274	245	
52	290	289	285	281	279	274	244	
56	263	262	258	254	252	251	244	
60	240	238	234	230	229	227	226	
64	219	218	214	210	208	207	205	
68	201	200	196	192	190	189	187	
72	185	184	180	176	174	173	171	
76	171	169	165	161	160	158	157	
80	158	156	152	148	147	145	144	
84	146	144	141	137	135	134	132	
88	135	134	130	126	125	123	121	
92	125	124	120	116	115	113	112	
96	116	115	111	107	106	104	103	
100	108	106	103	99.3	98	96.5	94.9	
108			88.3	84.5	83.2	81.7	80.2	
116				71.6	70.4	68.9	67.5	
124						57.7	56.3	
132							46.3	

Lifting Performance Table for Classic OMs

Lifting performance table for XLC30000 special boom SXT

Luffing mast radius 19m, luffing counterweight 210t, luffing counterweight radius 30 m, turntable counterweight 180t, vehicle body counterweight 140 t

Radius (m)	Boom Length (m)						
	114	120	126	132	138	144	150
24	472						
26	429	427					
28	391	390	385	347			
30	359	358	354	347	309	275	
32	331	330	326	322	309	275	246
34	306	305	301	297	296	275	246
36	284	283	279	275	274	272	246
38	265	263	260	256	254	253	246
40	247	246	242	238	237	235	234
44	217	215	212	208	206	205	203
48	191	190	186	182	181	179	178
52	170	169	165	161	159	158	156
56	152	150	146	143	141	139	138
60	136	134	131	127	125	124	122
64	122	120	117	113	111	110	108
68	110	108	104	100	99.4	97.8	96.2
72	99	97.6	93.8	89.9	88.4	86.9	85.3
76	89.2	87.8	84	80	78.6	77.1	75.5
80	80.3	78.9	75.1	71.2	69.8	68.2	66.6
84	72.2	70.8	67.1	63.1	61.8	60.2	58.6
88	64.9	63.5	59.7	55.8	54.4	52.9	51.3
92	58.1	56.8	53	49.1	47.8	46.2	44.7
96	51.9	50.6	46.8	43	41.6	40.1	38.5
100	46.1	44.8	41.1	37.3	35.9	34.4	32.9
108			30.9	27.1	25.8	24.3	22.8

7.Strengthened heavy-duty boom SHB-DS

Schematic diagram for XLC30000 strengthened heavy-duty boom working range in OM SHB-DS

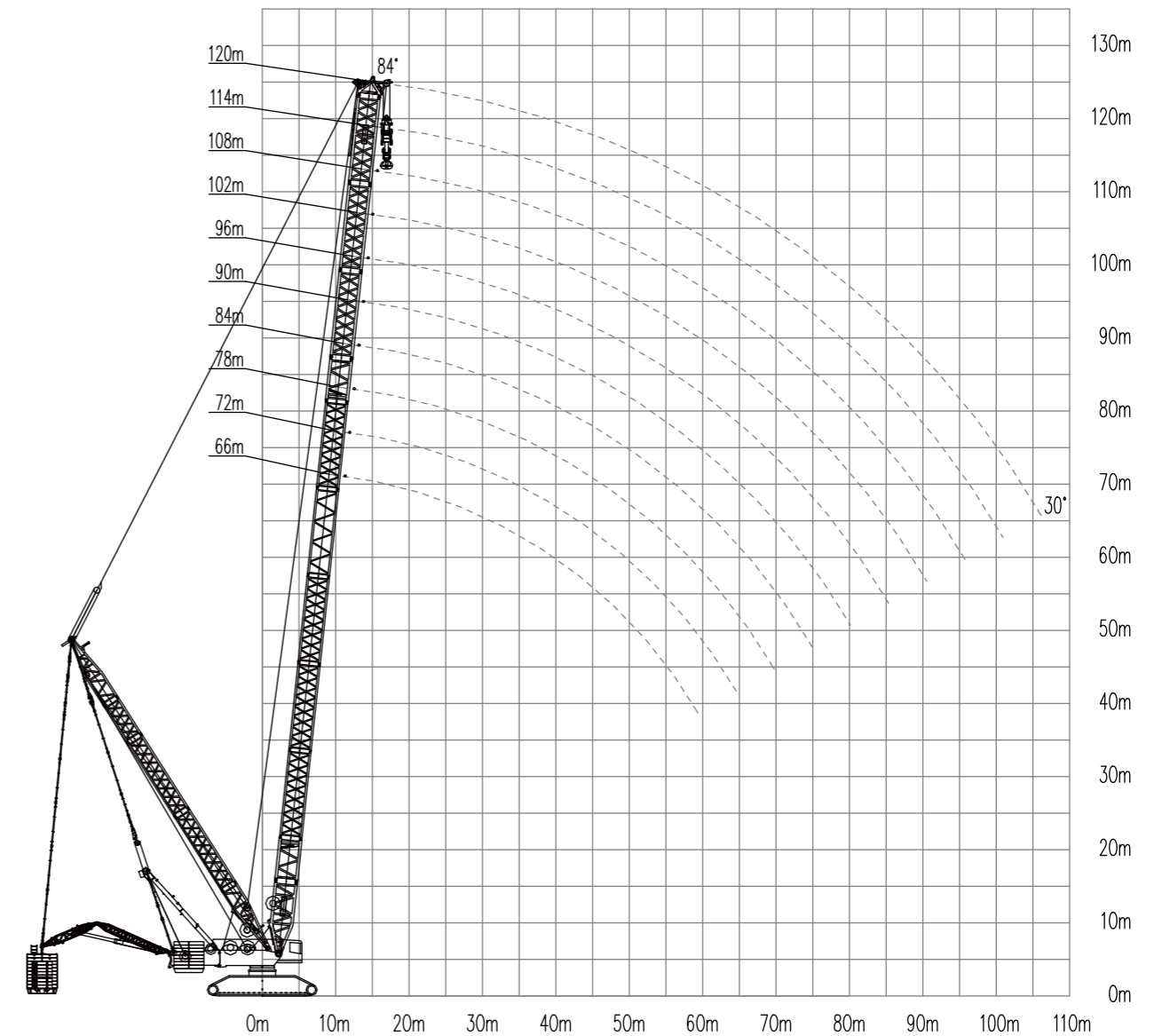

Lifting Performance Table for Classic OMs

Lifting performance table for XLC30000 strengthened heavy-duty boom SHB-DS

Luffing mast radius 26 m, luffing counterweight 800 t, luffing counterweight radius 30 m, turntable counterweight 300 t, vehicle body counterweight 140 t

Radius (m)	Boom Length (m)									
	66	72	78	84	90	96	102	108	114	120
12	1566	1474								
14	1566	1474	1380	1283	1184					
16	1566	1474	1380	1283	1184	1081	1028	974		
18	1527	1474	1380	1283	1184	1081	1028	974	920	865
20	1366	1364	1362	1283	1184	1081	1028	974	920	865
22	1235	1233	1230	1228	1184	1081	1028	974	920	865
24	1124	1123	1120	1118	1112	1081	1028	974	920	865
26	1026	1027	1024	1022	1016	1015	1012	974	920	865
28	941	945	942	940	934	933	929	928	920	865
30	863	874	871	869	863	862	858	857	850	848
32	794	812	809	807	801	800	796	795	788	786
34	734	754	755	753	747	745	742	740	733	731
36	681	700	706	704	698	697	694	692	684	682
38	634	652	663	661	655	654	650	648	641	639
40	591	609	623	622	616	615	611	609	602	600
44	518	534	547	555	549	548	544	542	535	533
48	456	472	483	495	492	492	489	487	479	477
52	403	419	430	441	443	442	440	439	431	429
56	357	373	384	394	399	400	398	397	389	388
60	316	333	344	354	358	364	362	360	353	351
64		296	308	319	323	330	330	329	321	320
68			276	287	291	298	303	301	293	292
72				258	263	270	275	277	268	267
76				231	237	244	249	254	246	245
80					213	221	226	231	227	225
84						199	204	210	207	207
88							185	190	188	191
92								172	170	174
96								155	153	157
100									137	142
106										120

8.Strengthened lightweight boom SLB-DS

Schematic diagram for XLC30000 strengthened lightweight boom working range in OM SLB-DS

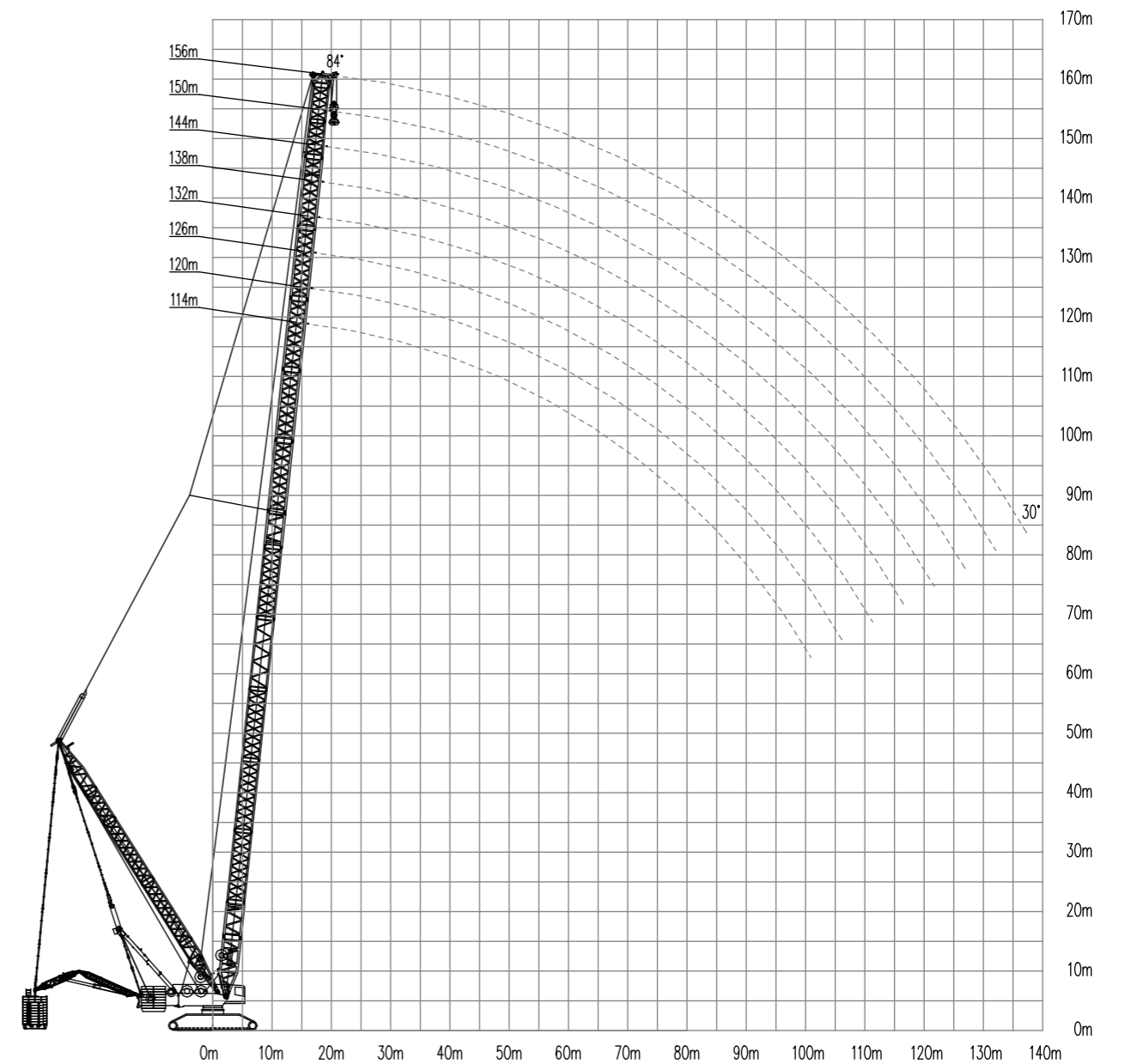

Lifting Performance Table for Classic OMs

Lifting performance table for XLC30000 strengthened lightweight boom SLB-DS

Luffing mast radius 26 m, luffing counterweight 800 t, luffing counterweight radius 30 m, turntable counterweight 300 t, vehicle body counterweight 140 t

Radius (m)	Boom Length (m)							
	114	120	126	132	138	144	150	156
18	865	809	752	695				
20	865	809	752	695	636	577	516	
22	865	809	752	690	631	577	516	485
24	865	809	746	682	622	570	516	479
26	865	809	738	673	612	561	508	471
28	865	809	728	664	604	552	499	464
30	865	809	719	655	594	544	492	457
32	808	806	709	645	585	535	483	450
34	754	752	699	635	575	526	475	442
36	705	703	690	626	566	518	468	435
38	662	660	653	618	558	509	460	428
40	623	621	614	608	549	501	453	421
44	556	554	548	545	513	477	438	407
48	500	498	492	489	443	412	409	392
52	453	451	445	435	388	360	355	339
56	413	410	405	386	343	317	311	296
60	377	375	370	346	306	282	275	260
64	346	344	339	312	275	252	245	230
68	318	316	311	284	249	226	219	205
72	293	291	286	260	226	204	196	183
76	271	269	264	240	206	186	177	164
80	251	249	244	222	190	169	160	147
84	230	231	227	207	175	154	145	133
88	210	214	208	194	162	142	132	120
92	192	196	191	183	151	131	121	108
96	176	179	175	175	141	121	111	98.3
100	160	164	161	162	133	112	101	89.1
108			134	136	121	98.7	86.7	73.4
116				112	112	88.7	75.1	60.9
124						82.9	66.7	51.3
132							61.9	44.2
138								41

9. Strengthened special jib SHV-DS

Schematic diagram for XLC30000 strengthened special jib working range in OM SHV-DS

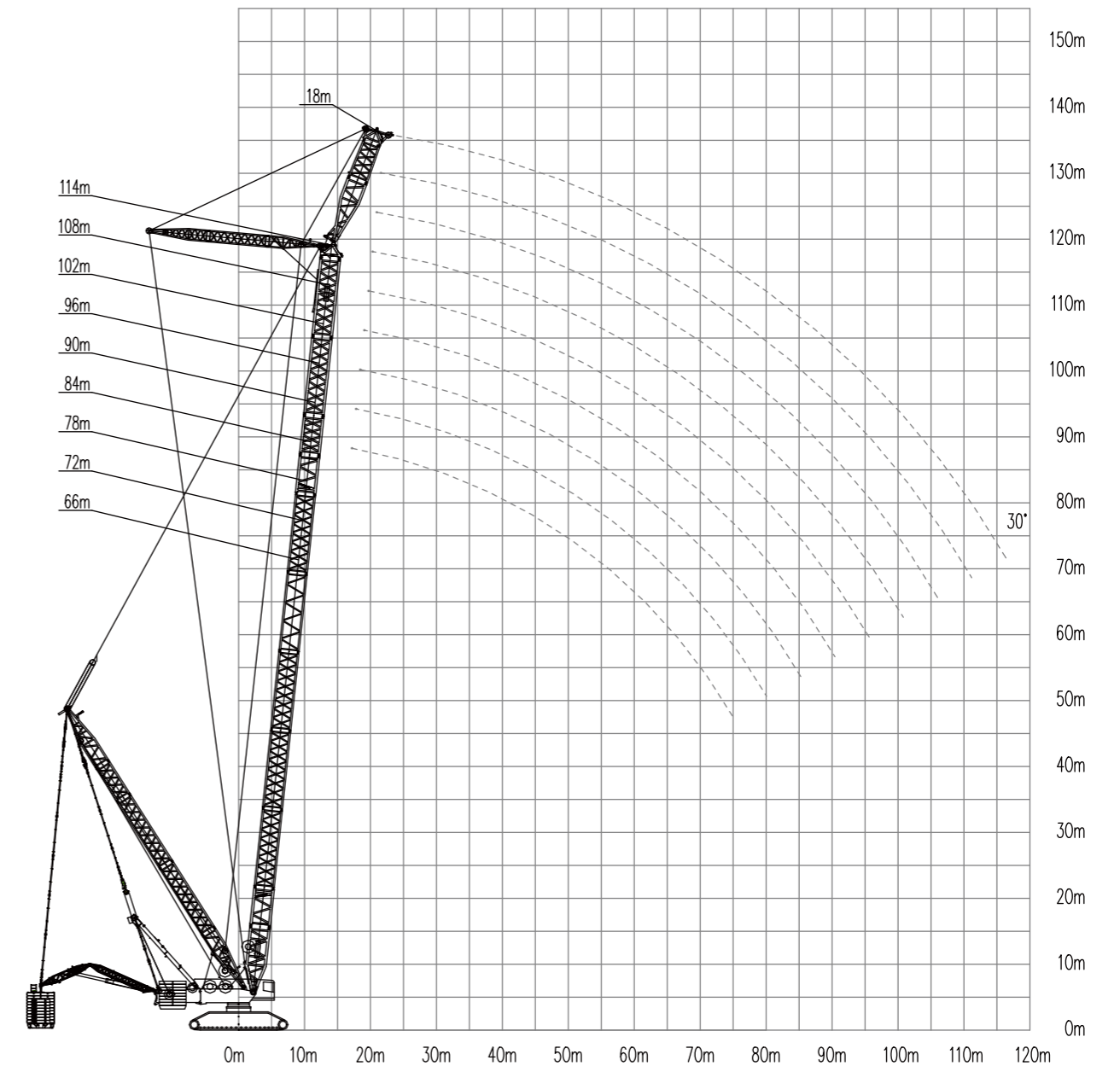

Lifting Performance Table for Classic OMs

Lifting performance table for XLC30000 strengthened special jib SHV-DS

Luffing mast radius 26 m, luffing counterweight 800 t, luffing counterweight radius 30 m, turntable counterweight 300 t, vehicle body counterweight 140 t

Radius (m)	Boom Length (m)								
	66	72	78	84	90	96	102	108	114
18	900								
20	900	900							
22	900	900	900						
24	900	900	900	900					
26	900	900	900	900	900				
28	900	900	900	900	900	900			
30	834	845	854	900	900	900	811	736	697
32	805	816	814	810	806	804	800	736	697
34	749	759	757	753	749	748	743	736	697
36	696	709	707	703	698	697	693	690	686
38	653	664	662	658	653	652	648	645	641
40	610	624	621	618	613	611	607	604	600
44	536	549	552	548	543	542	537	534	530
48	474	485	494	490	485	483	479	476	472
52	422	432	442	441	436	434	430	427	422
56	377	386	395	400	394	392	388	385	380
60	337	345	354	361	358	356	352	348	344
64	302	310	318	324	325	324	320	316	311
68	271	279	286	292	295	295	291	288	283
72	242	250	257	264	266	269	266	263	258
76	215	224	231	238	240	245	242	239	235
80		200	208	214	216	221	222	218	214
84			185	192	195	200	202	200	195
88			164	172	175	180	182	182	178
92				153	156	161	164	166	162
96					138	144	147	149	148
100						128	131	133	133
108							101	104	105
116									77.1

10. Strengthened fixed jib SLF-DS

Schematic diagram for XLC30000 strengthened fixed jib working range in OM SLF-DS

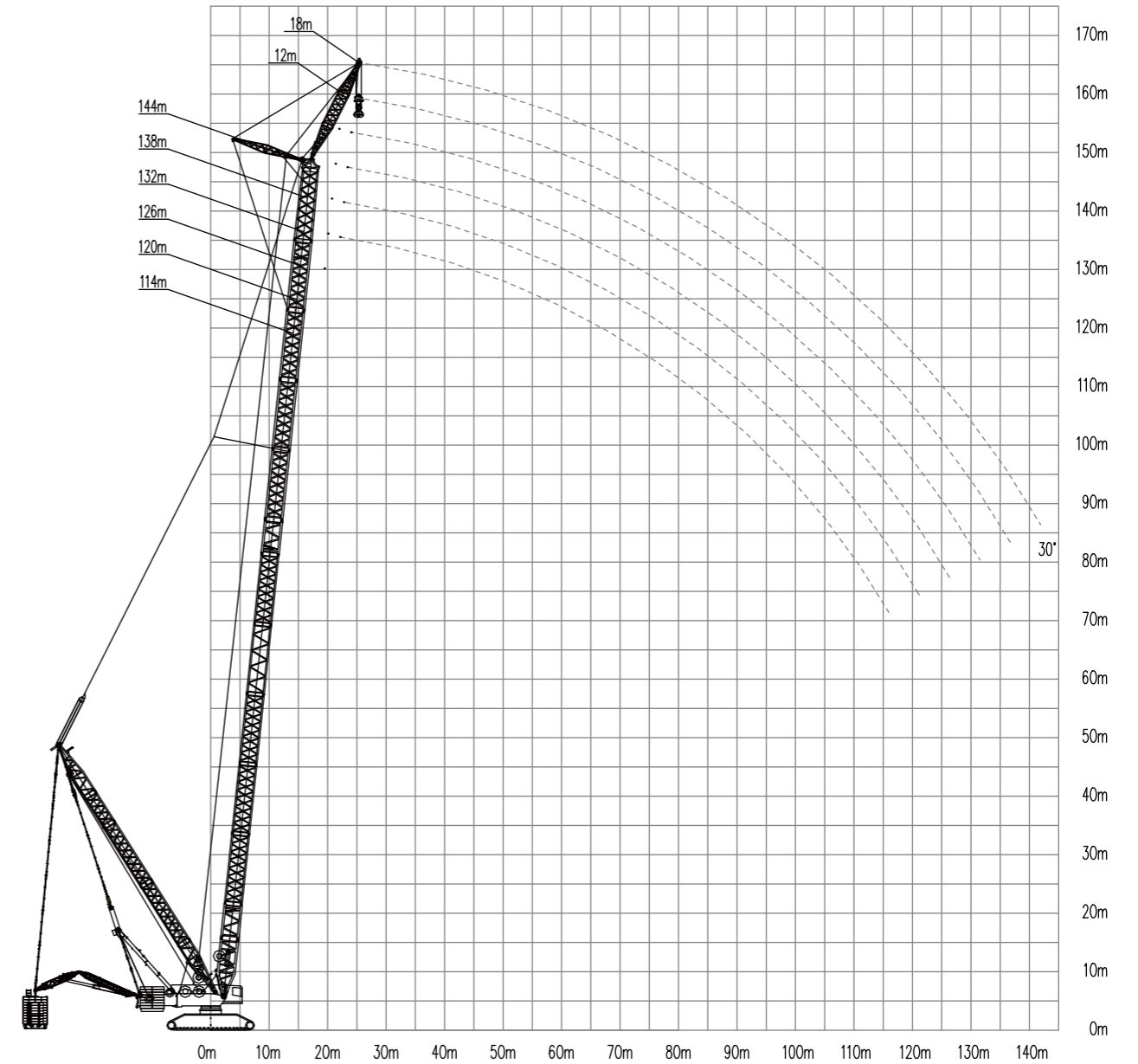

Lifting Performance Table for Classic OMs

Lifting performance table for XLC30000 strengthened fixed jib SLF-DS

Jib length 12m

Turntable counterweight 300t; vehicle body counterweight: 140t

Luffing counterweight 800t, luffing counterweight radius 30 m

Boom Length (m)						
Radius (m)	114	120	126	132	138	144
20	400					
22	400	400	400	400		
24	400	400	400	400	400	400
26	400	400	400	400	400	400
28	400	400	400	400	400	400
30	400	400	400	400	400	400
32	400	400	400	400	400	400
34	400	400	400	400	400	383
36	400	400	400	400	400	375
38	400	400	400	400	400	369
40	400	400	400	400	379	361
44	400	400	400	400	365	349
48	400	400	383	369	352	336
52	400	400	368	354	339	325
56	400	400	354	341	327	313
60	379	377	342	329	315	302
64	348	346	332	318	302	292
68	321	319	313	309	295	283
72	297	295	289	286	281	274
76	275	273	267	264	260	257
80	255	253	247	245	240	237
84	235	235	229	227	222	220
88	216	219	213	211	206	203
92	199	202	198	196	191	188
96	184	186	184	182	177	174
100	169	172	170	169	165	162
108	142	145	143	145	140	139
116		121	120	122	118	117
124				101	98.3	98.1
132					79.2	79

Jib length 18 m

Turntable counterweight 300t; vehicle body counterweight: 140t

Luffing counterweight 800t, luffing counterweight radius 30 m

Boom Length (m)						
Radius (m)	114	120	126	132	138	144
24	400	400	400			
26	400	400	400	370	352	336
28	400	400	379	362	345	330
30	400	400	370	355	340	324
32	400	400	361	349	333	319
34	400	400	352	341	327	313
36	400	400	344	333	321	307
38	400	400	337	326	315	301
40	400	400	329	319	308	296
44	400	400	316	306	295	286
48	400	376	303	293	284	276
52	378	370	292	283	273	265
56	371	363	282	272	263	256
60	366	358	273	263	254	247
64	353	350	264	255	246	239
68	325	323	257	248	239	232
72	301	299	250	241	232	226
76	279	277	244	235	226	220
80	259	257	238	229	221	214
84	241	239	233	224	216	209
88	224	223	217	215	210	204
92	207	207	202	199	195	192
96	191	193	188	186	181	178
100	176	178	175	173	168	166
108	149	152	150	150	146	143
116	125	128	127	128	124	123
124		107	106	107	104	103
132				89	86	85.3
140						67.5

46

XLC30000 CRAWLER CRANE

P39-P50 Transport Plan

Transport Plan

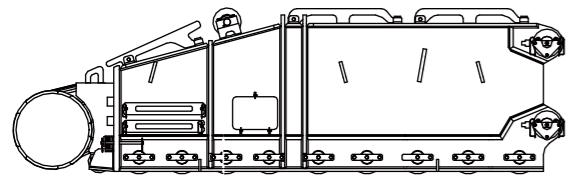

Front section of crawler beam ×2	
L	7.85 m
W	2.04 m
H	2.36 m
W	30.35 t

Including the thrust wheel and reducer, but not the crawler shoe

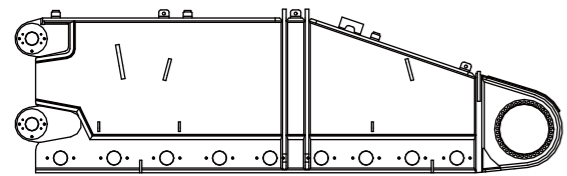

Rear section of crawler beam ×2	
L	7.52 m
W	2.04 m
H	2.36 m
W	26.92 t

Including the thrust wheel and reducer, but not the crawler shoe



Crawler shoe assembly ×2	
L	— m
W	2 m
H	— m
W	43.58 t



Connecting beam ×2	
L	10.15 m
W	2.49 m
H	2.4 m
W	30.97 t

Including the chassis jack cylinder and pin shaft cylinder

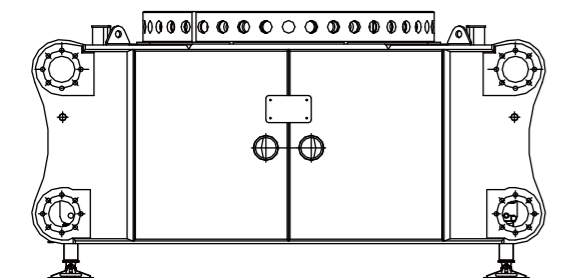

Vehicle frame ×1	
L	5.66 m
W	3.72 m
H	2.76 m
W	37.15 t

Including outriggers

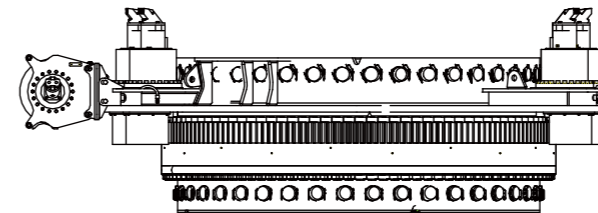

Slewing assembly ×1	
L	5.48 m
W	3.75 m
H	1.85 m
W	43.85 t

Including the slewing scentral rotary joint system, slewing bearing, and

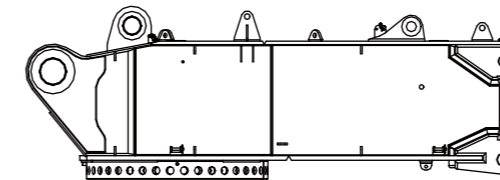

Front turntable assembly ×1	
L	8.66 m
W	3.48 m
H	3.03 m
W	38.23 t

Including the walking surface in the front of the turntable

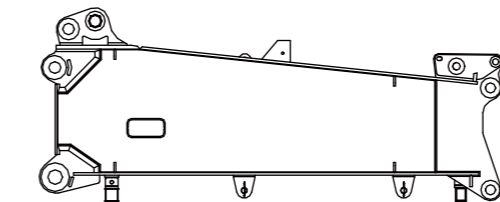

Rear turntable assembly ×1	
L	7.3 m
W	3.44 m
H	3.04 m
W	18.71 t

Including the inner walking surface, gantry lifting cylinder

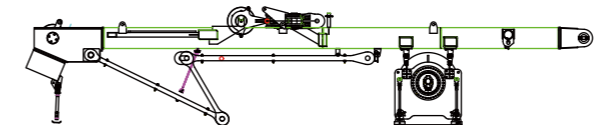

Gantry assembly ×1	
L	14.9 m
W	3.51 m
H	3.13 m
W	35.13 t

Including the mast luffing system and wire rope

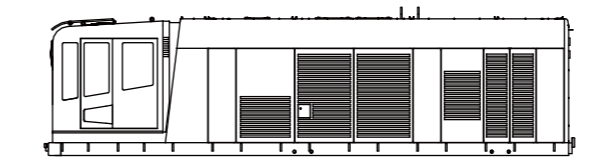

Power box ×1	
L	12.5 m
W	2.9 m
H	3.2 m
W	35 t

Including the operator's cab

Transport Plan

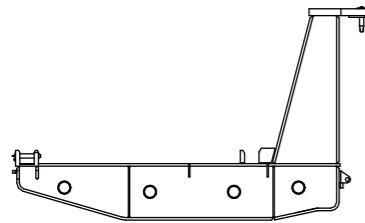

Power box bracket	×2
L	4.17 m
W	2.48 m
H	0.8 m
W	2.47 t

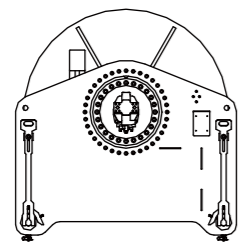

Hoist winch	×2
L	2.73 m
W	2.18 m
H	2.31 m
W	24.55 t

Including wire rope

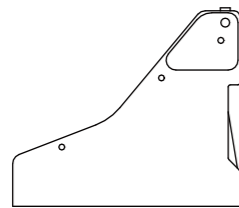

Vehicle body counterweight frame	×2
L	5.91 m
W	2.32 m
H	2.3 m
W	10.59 t

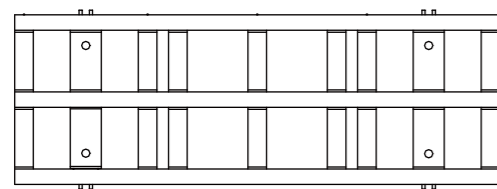

Main tray of turntable counterweight	×1
L	9.38 m
W	3.48 m
H	0.88 m
W	20.66 t

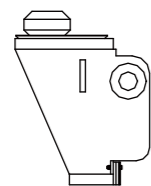

Small tray of turntable counterweight	×4
L	0.67 m
W	0.5 m
H	0.65 m
W	0.23 t

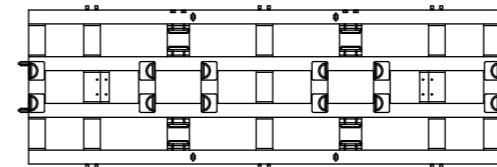

Main tray of luffing counterweight	×1
L	10.68 m
W	3.51 m
H	1.32 m
W	25.05 t

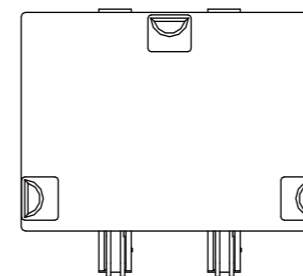

Side tray of luffing counterweight	×2
L	2.75 m
W	2.47 m
H	0.85 m
W	5.06 t



Luffing counterweight separation tray	×1
L	11.5 m
W	4.1 m
H	1.97 m
W	15.5 t

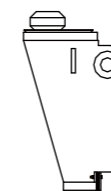

Small tray of luffing counterweight	×6
L	0.67 m
W	0.5 m
H	0.88 m
W	0.3 t

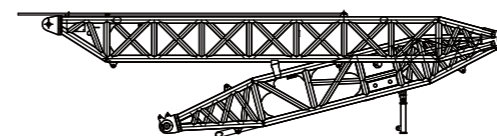

Lifting push unit	×1
L	10.8 m
W	3.58 m
H	2.95 m
W	14.2 t

Including push cylinder

Transport Plan

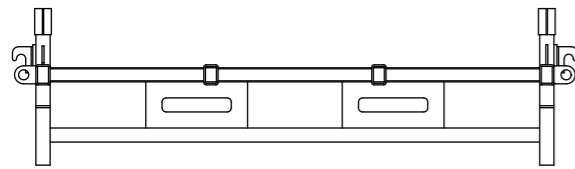

Transport assembly of backstop cylinder ×2

L	5.15 m
W	1.3 m
H	0.8 m
W	4 t

Including the boom backstop cylinder, mast backstop cylinder, and transport bracket

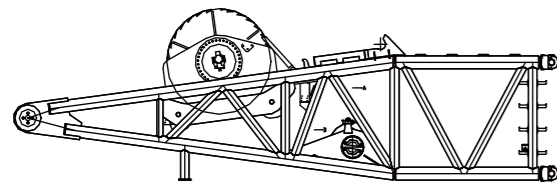

Mast base section ×1

L	10.41 m
W	2.99 m
H	3.27 m
W	41.3 t

Including boom luffing system

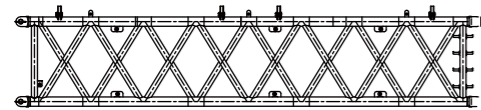

12 m section of mast ×2

L	12.26 m
W	2.88 m
H	2.65 m
W	13.3 t

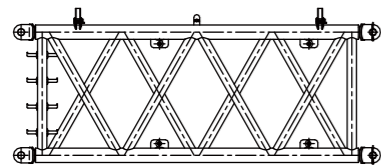

6 m section of mast ×1

L	6.26 m
W	2.88 m
H	2.65 m
W	6.95 t

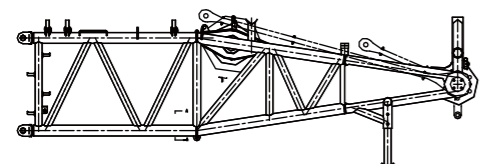

Top section of mast ×1

L	10.61 m
W	3.19 m
H	3.22 m
W	20.3 t

Including the auxiliary pendant

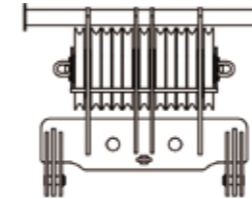

Boom luffing pulley block ×1

L	2.78 m
W	2.23 m
H	0.96 m
W	4.85 t

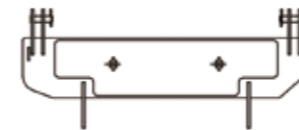

Mast crane sling ×1

L	3.81 m
W	1.58 m
H	0.36 m
W	5.05 t

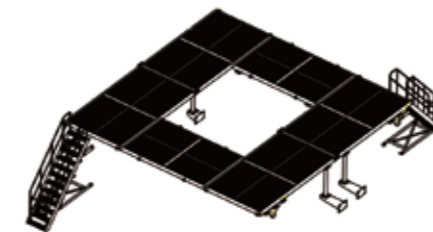

Chassis walking surface ×1

L	— m
W	— m
H	— m
W	6.92 t

Detach and transport

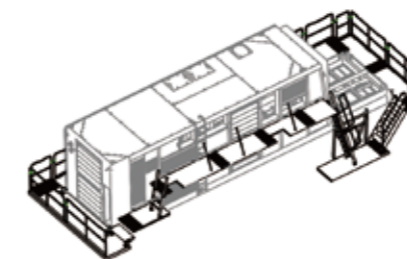

Left walking surface ×1

L	— m
W	— m
H	— m
W	13.99 t

Detach and transport



Base section of main boom ×1

L	10.56 m
W	3.73 m
H	3.49 m
W	25.63 t

Transport Plan

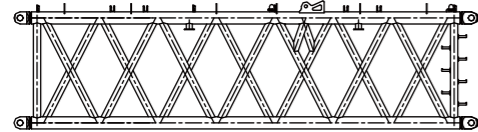

Boom 12m section A ×1	
L	12.33 m
W	3.73 m
H	3.42 m
W	20.03 t

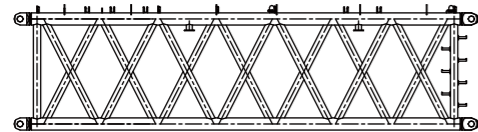

Boom 12m section B ×1	
L	12.33 m
W	3.73 m
H	3.35 m
W	17.55 t

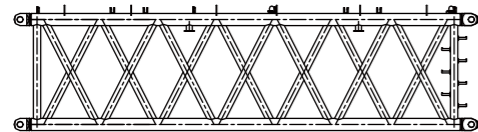

Boom 12m section C ×3	
L	12.33 m
W	3.73 m
H	3.35 m
W	15.38 t

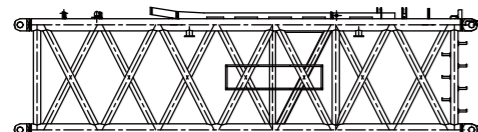

Boom 12m section D ×1	
L	12.33 m
W	3.73 m
H	3.43 m
W	21.01 t

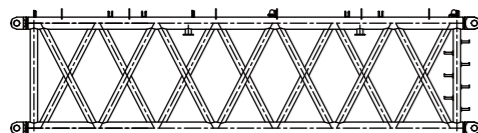

Boom 12m section E ×2	
L	12.33 m
W	3.73 m
H	3.35 m
W	17.53 t

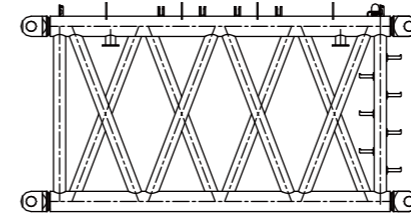

Boom 6m section A ×1	
L	6.33 m
W	3.73 m
H	3.35 m
W	11.14 t

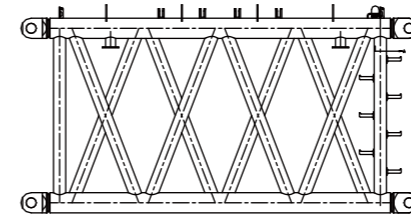

Boom 6m section B ×1	
L	6.33 m
W	3.73 m
H	3.35 m
W	10.05 t

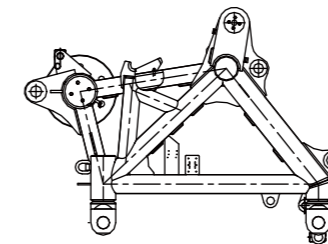

Boom head ×1	
L	4.26 m
W	3.73 m
H	2.96 m
W	14.51 t

Including the auxiliary pendant

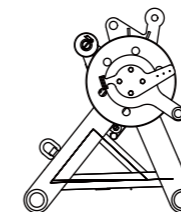

Boom winch tackle A ×6	
L	2.34 m
W	1.8 m
H	2.12 m
W	7.02 t

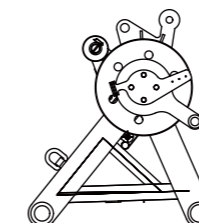

Boom winch tackle B ×1	
L	2.21 m
W	1.8 m
H	2.12 m
W	6.79 t

Transport Plan

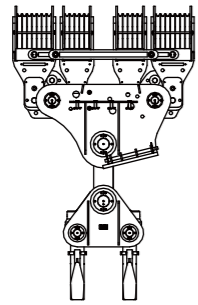

1400 t hook block	×1
L	1.69 m
W	4.16 m
H	7.38 m
W	45 t

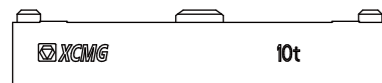

Counterweight slab	×104
L	2.75 m
W	2 m
H	0.54 m
W	10 t

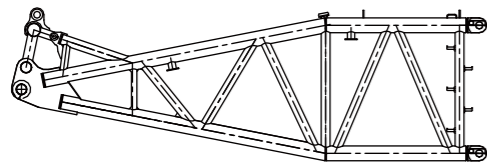

Base section of luffing jib	×1
L	10.39 m
W	3.73 m
H	3.55 m
W	15.73 t

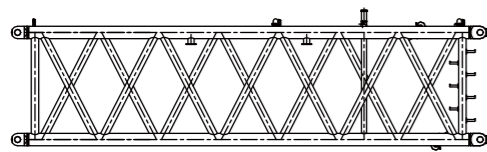

Luffing jib 12m section D	×1
L	12.33 m
W	3.73 m
H	3.33 m
W	13.71 t

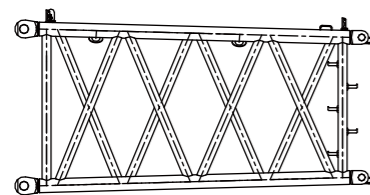

Luffing jib 6m transition section	×1
L	6.29 m
W	3.65 m
H	3.31 m
W	7.15 t

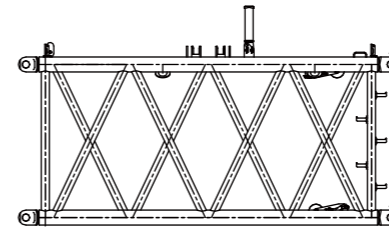

Luffing jib 6m section	×1
L	6.25 m
W	3.05 m
H	2.99 m
W	6.08 t

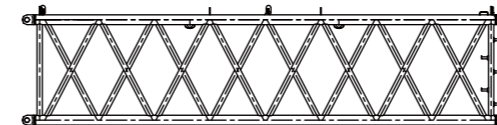

Luffing jib 12m section A	×1
L	12.25 m
W	3.05 m
H	2.99 m
W	11.03 t

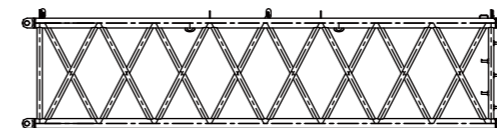

12mB section of luffing jib	×4
L	12.25 m
W	3.05 m
H	2.99 m
W	9.51 t

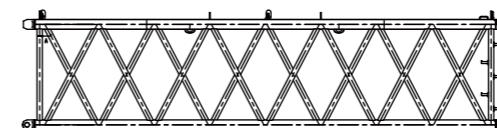

Luffing jib 12m section C	×2
L	12.25 m
W	3.05 m
H	2.99 m
W	8.33 t

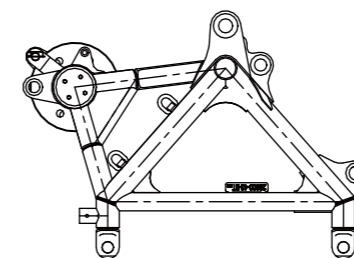

Luffing jib head	×1
L	3.68 m
W	3.16 m
H	2.63 m
W	7.83 t

Including the auxiliary pendant

Transport Plan

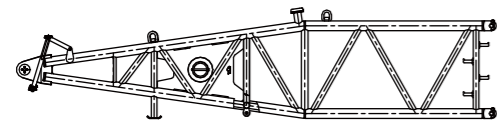

Base section of the front bracket ×1	
L	8.74 m
W	3.32 m
H	2.01 m
W	5.41 t

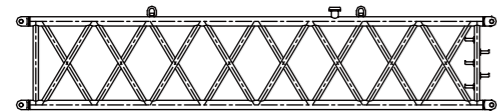

Middle section of the luffing jib on the front bracket ×1	
L	9.18 m
W	2.92 m
H	1.96 m
W	3.26 t

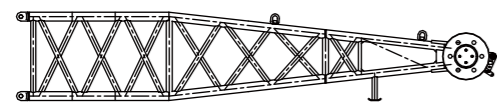

Top section of the luffing jib on the front bracket ×1	
L	9.71 m
W	2.88 m
H	1.78 m
W	6.44 t

Including the auxiliary pendant

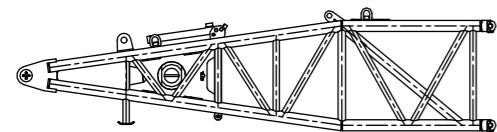

Base section of the luffing jib on the rear bracket ×1	
L	7.74 m
W	2.98 m
H	1.94 m
W	5.53 t

Including backstop cylinder

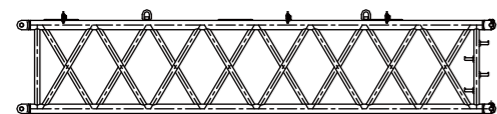

Middle section of the luffing jib on the rear bracket ×1	
L	9.18 m
W	3.71 m
H	1.98 m
W	3.31 t

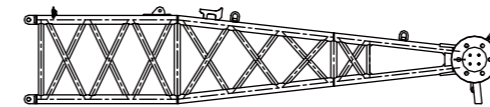

Top section of the luffing jib on the rear bracket ×1	
L	9.68 m
W	3.71 m
H	1.98 m
W	6.69 t

Including the auxiliary pendant

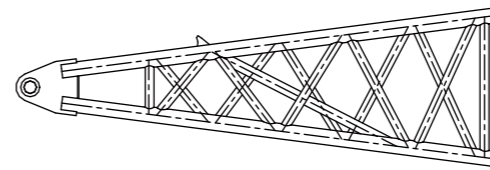

Base section of fixed jib ×1	
L	6.31 m
W	2.78 m
H	1.98 m
W	4.02 t

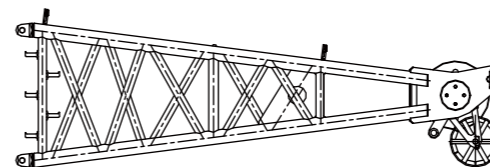

Top section of fixed jib ×1	
L	6.87 m
W	2.81 m
H	2.19 m
W	7.01 t

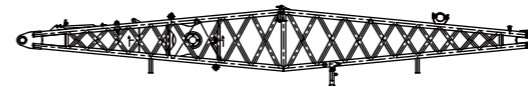

Fixed jib bracket ×1	
L	12.23 m
W	3.07 m
H	1.78 m
W	4.01 t

Including the rear backstop rod

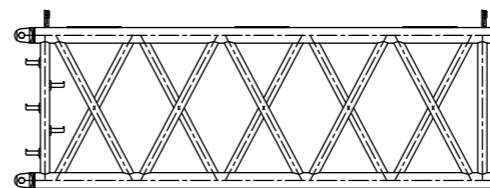

6m section of fixed jib ×1	
L	6.18 m
W	2.79 m
H	1.99 m
W	2.78 t

Including the auxiliary pendant

Transport Plan

memorandum

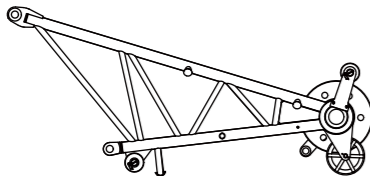

Single top	×1
L	4.79 m
W	2.24 m
H	2.22 m
W	2.3 t

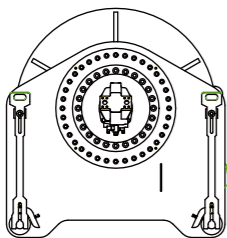

Single pulley winch	×1
L	2.9 m
W	1.7 m
H	1.75 m
W	15 t

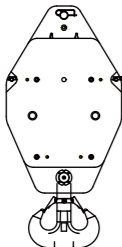

100 t hook block	×1
L	1.1 m
W	0.72 m
H	2.35 m
W	5 t

Data included in this document will be updated with the continuous product upgrading. Please refer to the actual product. January 2022

memorandum
